

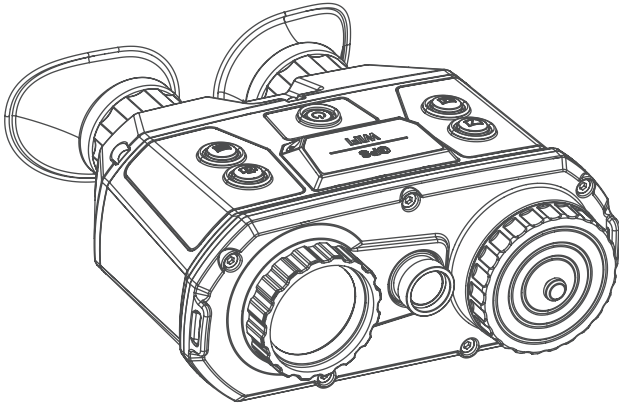

AGM
GLOBAL
VISION



EXPLORATOR FSB50-640

THERMAL FUSION BINOCULAR

USER MANUAL

© 2020 AGM Global Vision. All rights reserved.

This documentation is subject to change without notice.

No parts of this manual, in whole or in part, may be copied, photocopied, translated, or transmitted by any electronic medium or in machine-readable form without the prior written permission of AGM Global Vision.

If you have questions that are not covered in this manual, or need service, contact AGM Global Vision customer support for additional information prior to returning a product.

AGM Global Vision

173 West Main Street

PO Box 962

Springerville, AZ 85938

Tel. 928.333.4300

Fax 480.393.4882

support@agmglobalvision.com

www.agmglobalvision.com

EXPORT INFORMATION

Buyer acknowledges that all products supplied by AGM Global Vision are subject to U.S. export control laws, including, but not limited to, the Export Administration Regulations, the International Economic Emergency Powers Act, and various U.S. embargoes and sanctions. AGM Global Vision products may not be exported, re-exported, or transferred contrary to U.S. export control laws. In particular, AGM Global Vision products may not be exported, re-exported, or transferred to prohibited countries, individuals, organizations, or entities, including but not limited to those individuals and entities listed on the List of Specially Designated Nationals and Blocked Persons administered or maintained by the U.S. Office of Foreign Assets Control ("OFAC"), the various lists maintained by the Bureau of Industry and Security of the Department of Commerce, and the U.S. State Department and Buyer represents and warrants that neither Buyer nor any of its officers, directors, or employees are on such lists. Distribution or resale by Buyer to such countries, individuals, organizations, or entities is expressly prohibited. Buyer has and will maintain a positive process to ensure compliance with this Section.

FCC INFORMATION

Please take attention that changes or modification not expressly approved by the party responsible for compliance could void the user's authority to operate the equipment.

FCC compliance: This equipment has been tested and found to comply with the limits for a Class A digital device, pursuant to part 15 of the FCC Rules. These limits are designed to provide reasonable protection against harmful interference when the equipment is operated in a commercial environment. This equipment generates, uses, and can radiate radio frequency energy and, if not installed and used in accordance with the instruction manual, may cause harmful interference to radio communications. Operation of this equipment in a residential area is likely to cause harmful interference in which case the user will be required to correct the interference at his own expense.

FCC Conditions

This device complies with part 15 of the FCC Rules. Operation is subject to the following two conditions:

1. This device may not cause harmful interference.
2. This device must accept any interference received, including interference that may cause undesired operation.

EU CONFORMITY STATEMENT



This product and - if applicable - the supplied accessories too are marked with "CE" and comply therefore with the applicable harmonized European standards listed under the EMC Directive 2014/30/EU, the RoHS Directive 2011/65/EU



2012/19/EU (WEEE directive): Products marked with this symbol cannot be disposed of as unsorted municipal waste in the European Union. For proper recycling, return this product to your local supplier upon the purchase of equivalent new equipment, or dispose of it at designated collection points. For more information see: www.recyclethis.info



2006/66/EC (battery directive): This product contains a battery that cannot be disposed of as unsorted municipal waste in the European Union. See the product documentation for specific battery information. The battery is marked with this symbol, which may include lettering to indicate cadmium (Cd), lead (Pb), or mercury (Hg). For proper recycling, return the battery to your supplier or to a designated collection point. For more information see: www.recyclethis.info

INDUSTRY CANADA ICES-003 COMPLIANCE

This device meets the CAN ICES-3 (A)/NMB-3(A) standards requirements.

LIST OF CONTENTS

TITLE	PAGE
Safety Summary	5
1. GENERAL INFORMATION	6
1.1 System Description	6
1.2 Key Features	7
1.3 Standard Components	8
2. OPERATING INSTRUCTIONS	9
2.1. Basic Operations	9
2.2 Binoculars Setup	13
2.3 Display Settings	14
2.4 Palettes Settings	16
2.5 Wi-Fi Functions	17
2.6 GPS Functions	18
2.7 Capture Setting	18
2.8 Video Setting	18
2.9 Reset Default Setting	19
3. MAINTENANCE	20
3.1 Maintenance	20
3.2 Troubleshooting	21
4. WARRANTY INFORMATION	22
4.1 Warranty Information and Registration	22
5. SPECIFICATIONS	24
5.1 Specifications	24

SAFETY SUMMARY

- Read and follow all instructions
- Read all warnings
- Only use the attachments/accessories specified by the manufacturer
- All service must be provided by the manufacturer

WARNING:

This product contains natural rubber latex, which may cause potentially fatal allergic reactions! If you are allergic to latex, it is important that you strictly avoid exposure to products that contain it.

WARNINGS AND CAUTIONS:

- All electronic operation should be in strict compliance with the electrical safety regulations, fire prevention regulations and other related regulations in your local region.
- Please use the power adapter, which is provided by a proven manufacturer. The power consumption cannot be less than the required value.
- Do not connect several devices to one power adapter as adapter overload may cause over-heat or fire hazard.
- Do not drop the device or subject it to physical shock, and do not expose it to high electromagnetism radiation. Avoid the device installation on vibrations surface or places subject to shock (ignorance can cause equipment damage).
- Do not place the device in extremely hot (refer to the specification of the device for the detailed operating temperature), cold, dusty or damp locations, and do not expose it to high electromagnetic radiation.
- The device cover for indoor use should be kept from rain and moisture.
- Exposing the device to direct sun light, low ventilation or heat source such as heater or radiator is forbidden (ignorance can cause fire danger).
- Do not aim the device at the sun or extra bright places. A blooming or smear may occur otherwise (which is not a malfunction however), and affecting the endurance of sensor at the same time.
- For long-term storage of the battery, make sure you fully charge it every 6 months, to ensure the battery quality. Otherwise, you may damage the battery.

NOTES:

The detector spectral band provides better visibility through smoke, dust, rain, smog, etc.

Infrared radiation does not travel through glass. As a result, the binoculars does not detect objects if they are behind glass windows or other barriers.

1 GENERAL INFORMATION

1.1 SYSTEM DESCRIPTION

AGM Explorator FSB50-640 Handheld Thermal & Optical Bi-spectrum Binocular is equipped with ultra-low light optical detector, 640×512 thermal detector, 1024×768 OLED display and eyepiece with large field of view. The device can quickly discover and locate hiding objects even under extreme environment, such as smoke, fog, rain and snow. It can be widely applied to scenarios like patrol, law enforcement, search and rescue, drug enforcement, anti-smuggling and suspect capture.

Due to its waterproof capability the device performs well even in severe weather conditions and challenging environment. The Explorator's user-friendly interface, comfortable and ergonomic buttons makes adoption and application incredibly simple. The thermal imaging unit offers many different variants of image palettes: white hot/black hot, etc. that can be easily adapted depending on different environmental conditions.

The unit can be easily mounted on a tripod which grants operator convenient/hands free use of thermal binocular.

This high-tech bi-ocular can take four 18650 rechargeable Lithium batteries for more than 7 hours operating time. Integrated proximity sensor saves energy. When sensor detects eyes, the OLED screen turns on, otherwise the OLED screen is off. In addition, an external power supply (5 V) provides an increase in operating time.

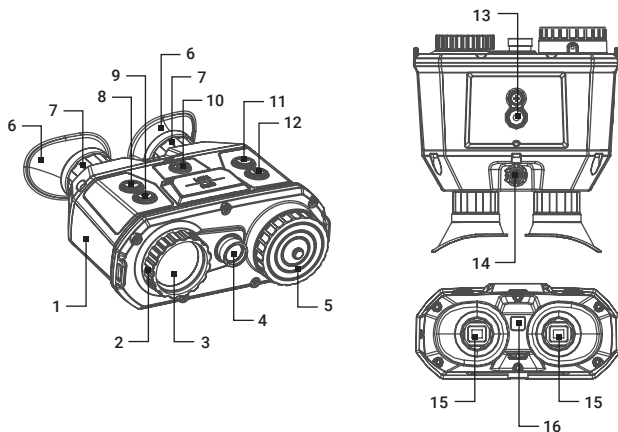

FIGURE 1-1. MAIN PARTS

TABLE 1-1. MAIN PARTS

ITEM	DESCRIPTION	ITEM	DESCRIPTION
1	Body	9	Capture Button
2	Focus Ring	10	Power Button
3	Thermal Channel Lens	11	Mode Button
4	Optical Channel Lens	12	Adjust Button
5	Battery Compartment	13	Tripod Screw
6	Eyecup	14	Aviation Connector
7	Diopter Adjustment Ring	15	Eyepiece
8	Menu Button	15	Proximity Sensor

1.2 KEY FEATURES

- Bi-spectrum image fusion and object highlight (detail enhancement and target recognition)
- Selection of thermal view channel, visible light channel, or both them combined
- High resolution 640×512 thermal channel and 1280×960 optical channel
- Digital Detail Enhancement (DDE)
- Dynamic Noise Reduction (3D DNR)
- Adaptive Automatic Gain Control (AGC)
- Multiple color palettes
- High-sensitivity optical channel for ultra-low illumination conditions (0.001 lux)
- 0.39-inch OLED display
- Automatic OLED backlight
- Manual focus for thermal lens
- Video recording, replay, picture snapshot and search (capable to review the event on device)
- Wi-Fi hotspot
- GPS Function
- More than 7 hours continuous running
- Proximity sensor to save power
- Stadiametric rangefinder
- Waterproof, IP67
- Limited 3-Year Warranty

1.3 STANDARD COMPONENTS

The standard components are shown in Figure 1-2 and listed in Table 1-2. The ITEM column indicates the number used to identify items in Figure 1-2.

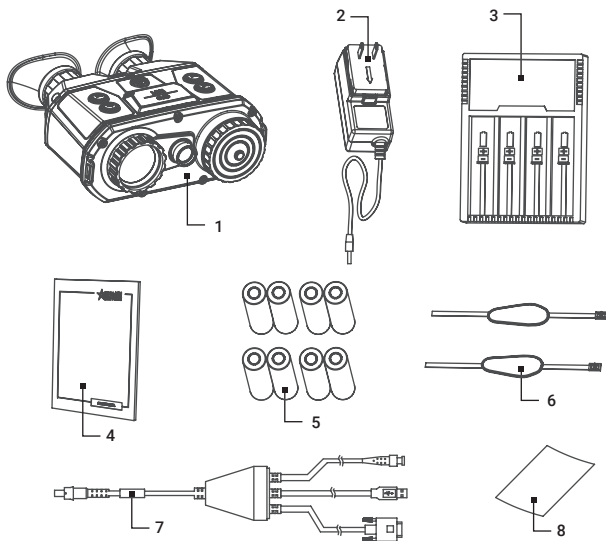

FIGURE 1-2. STANDARD COMPONENTS

TABLE 1-2. STANDARD COMPONENTS

ITEM	DESCRIPTION	QUANTITY
1	Binocular	1
2	Power Adapter	1
3	Battery Charger	1
4	Operation Manual	1
5	Battery	8
6	Straps	2
7	Aviation Plug Cables	1
8	Non-Dust Cloth	1

2 OPERATING INSTRUCTIONS

2.1. BASIC OPERATIONS

2.1.1 DEVICE CHARGING

For the first use, and when the device is running low, charge the batteries with your charger.

1. Take the proper plug adapter.
2. Push and hold it, at the mean time slide it toward the inside to assemble the power adapter.

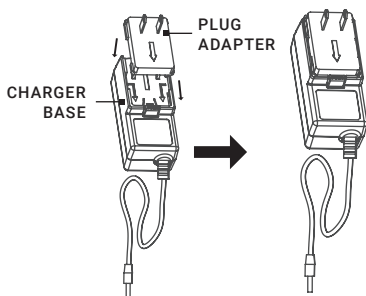

FIGURE 2-1. PLUG ADAPTER INSTALLATION

3. Connect the power adapter to the battery charger.

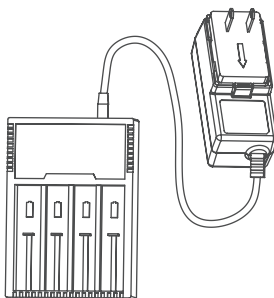

FIGURE 2-2. BATTERY CHARGER CONNECTION

- Insert the batteries in the charger with positive/negative terminals corresponded.

NOTE:

When the charger is powered on, the LCD display automatically lights up, and all the battery. The charger will detect the battery and charge it.

TABLE 2-1. BATTERY CHARGER STATUS

NO.	INDICATORS	FUNCTIONS
1	Model & battery bars	Standby mode
2	Unlighted	Power-saving mode. Press any button to activate it
3	Err	Battery is damaged
4	Blinking	Battery is being charged
5	Chg. Finish	Battery is fully charged

- Complete battery charging and disassemble the battery.

2.1.2 BATTERY INSTALLATION

Insert the batteries into the battery compartment.

- Rotate the battery cap counter-clockwise to disassemble it.

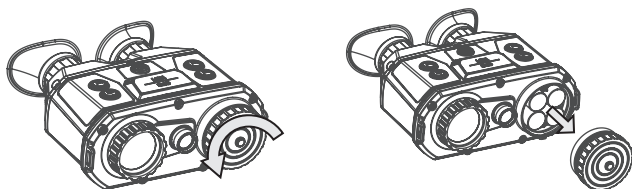

FIGURE 2-3. BATTERY CAP

- Insert four batteries with positive/negative marks match with that of the battery compartment.

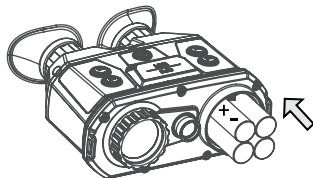

FIGURE 2-4. BATTERIES INSTALLATION

- Align the shape of battery cap with that of the batteries and cover the batteries.
- Rotate the battery cap clockwise to fix it.

2.1.3 CONTROL BUTTONS

The control buttons of the binoculars are shown below.

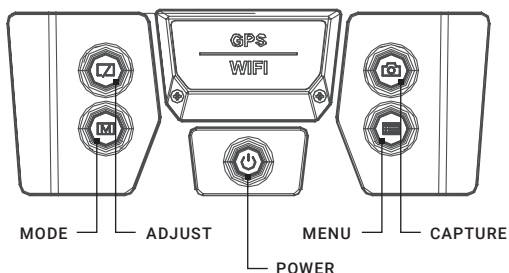







FIGURE 2-5. CONTROL BUTTONS

TABLE 2-2. BUTTON FUNCTIONS



BUTTON	FUNCTIONS
 Power	Press the button to emphasize the high-temperature target in the view in fusion mode. Hold the button to power on/off the device.
 Menu	Press the button to switch between White Hot mode and Black Hot mode. Hold the button to enter the menu.
 Capture	Press the button to capture the view. Hold the button to start/stop recording.
 Mode	Press the button to switch the pallets. Hold the button to adjust the digital zoom.
 Adjust	Press the button to switch between Near, Middle, and Far in fusion mode. Hold the button to correct non-uniformity of display.

2.1.4 POWER ON AND OFF

Power On

When the binoculars is sufficiently charged, press the  button to power on the binoculars.

NOTES:

- See the battery icon for the electricity quantity.  icon means battery is fully charged, and  icon means that the battery runs low.
- When the Low Power note shows, charge the battery.

Power Off

When the binoculars is running, hold the **(I)** button for four seconds to power off the binoculars.

2.1.5 FOCUSING

NOTES:

Do **NOT** touch the lens directly with your finger, or place any sharp objects near them.

1. Rotate the diopter adjustment rings to focus the ocular lens.
2. Rotate the focus ring to focus the thermal objective lens.

2.1.6 CABLE CONNECTION

ATTENTIONS:

- Do **NOT** drag the cables when you do the connecting, or when it is connected to the binoculars.
- To plug in/out the cable, hold the cable end and then plug in/out it.

Do **NOT** twist the cables, or the pins inside may be damaged.

Connect the binoculars with the aviation cable, and you can connect the device to your PC via USB interface or the display via the BNC interface.

Connect the aviation cable with the aviation Interface. Make sure the anchor points match with each other and insert the cable.

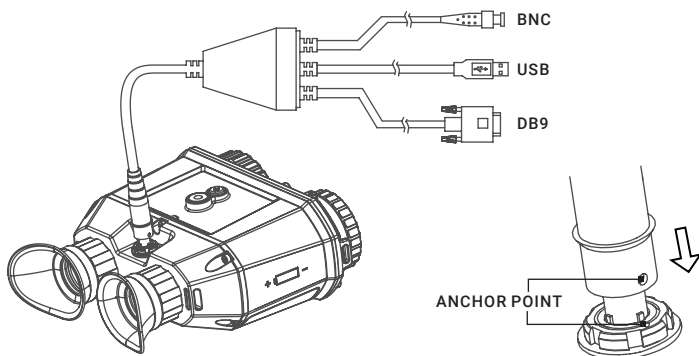



FIGURE 2-6. CABLE CONNECTION

To disconnect the cable, lift the cable.

2.2 BINOCULARS SETUP

2.2.1 MENU DESCRIPTION

Hold the  button to show the menu. Once the menu is displayed, use the buttons to controls as shown below.

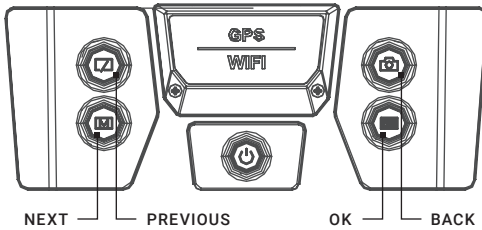

FIGURE 2-7. MENU BUTTONS

See the figure below for the menu interface.

NOTE:

The figure below is only for reference, the font size is readjusted for better viewing.

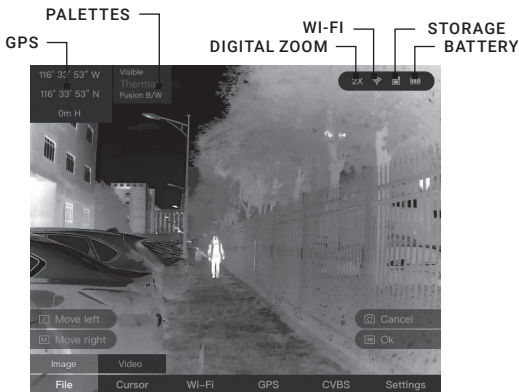





FIGURE 2-8. THE MAIN VIEW

2.2.2 LOCAL OUTPUT

Connect the binoculars to the display unit via CVBS interface of the aviation plug (BNC connector). Refer to Section 2.1.5

View the binoculars image on the display unit for details.

1. Hold the  button to show the menu of binoculars.
2. Press the  button and  button to move the cursor and open CVBS ON/OFF submenu.
3. Press the  button to confirm.

NOTE:

To disable the local output, go to **CVBS ON/OFF** submenu and press the  button.

2.2.3 FILE EXPORT

Connect the binoculars to your PC via USB interface of the aviation plug. Refer to Section 2.1.5.

Export the videos and snapshots with your PC.

1. In your PC, go to the **Removable Disk**.
2. Double-click to open the disk. View or copy the videos or snapshots.
3. Disconnect the binoculars with the PC.

2.3 DISPLAY SETTINGS









2.3.1 DISPLAY BRIGHTNESS & CONTRAST

Adjust the brightness and contrast of the screen display.









NOTE:

This adjustment also affects the brightness and contrast of menu, icons, etc.

Screen Brightness

1. Hold the  button to show the menu of binoculars.
2. Press the  button and  button to move the cursor to **Settings** submenu.
3. Press the  button to confirm.
4. Press the  button and  button to move the cursor to **Display Brightness** submenu.
5. Press the  button to confirm.
6. Press the  button and  button to set the brightness value. The higher, the brighter.

Screen Contrast

1. Hold the  button to show the menu of binoculars.
2. Press the  button and  button to move the cursor to **Settings** submenu.
3. Press the  button to confirm.
4. Press the  button and  button to move the cursor to **Display Contrast** submenu.
5. Press the  button to confirm.
6. Press the  button and  button to set the contrast value. The higher, the more contrasting.

2.3.2 IMAGE BRIGHTNESS & CONTRAST

Adjust the brightness and contrast of the image.

NOTE:

This adjustment only affects the brightness and contrast of image.

Image Brightness



















1. Hold the  button to show the menu of binoculars.
2. Press the  button and  button to move the cursor to **Settings** submenu.
3. Press the  button to confirm.
4. Press the  button and  button to move the cursor to **Image Brightness** submenu.
5. Press the  button to confirm.
6. Press the  button and  button to set the brightness value. The higher, the brighter.

Image Contrast

1. Hold the  button to show the menu of binoculars.
2. Press the  button and  button to move the cursor to **Settings** submenu.
3. Press the  button to confirm.
4. Press the  button and  button to move the cursor to **Image Contrast** submenu.
5. Press the  button to confirm.
6. Press the  button and  button to set the contrast value. The higher, the more contrasting.

2.3.3 CURSOR DISPLAY

Display the cursor on the live view, and the distance towards the target can be measured.





1. Hold the  button to show the menu of binoculars.
2. Press the  button and  button to move the cursor to **Cursor** submenu.



FIGURE 2-9. CURSOR SUBMENU

3. Press the  button to confirm.
4. Manually move the binoculars, align the horizontal line with the target bottom and measure the distance to the target.
The stadiametric rangefinder scale can be used to determine the distance to a 1.70 meters (5 ft 7 in) object from 100 m (upper scale mark number 1 to the right) to 1,000 m (upper scale mark number 10 to the left).
5. Hold the  button to exit.

NOTE:







To disable the cursor, go to **Cursor** submenu and press the  button.

2.3.4 DIGITAL ZOOM

Enable the digital zoom function to enlarge the image display.

1. Hold the  button to switch the digital zoom of binoculars. The value of digital zoom can be set to 1X, 2X, 3X, 4X.

2.3.5 OSD SETTING

1. Hold the  button to show the menu of binoculars.
2. Press the  button and  button to move the cursor to **Settings** submenu.
3. Press the  button to confirm.
4. Press the  button and  button to move the cursor to **OSD** submenu.
5. Press the  button to switch on/off OSD.

2.4 PALETTES SETTINGS

The binoculars has dual-lens: thermal and visible light lens. You can set the thermal/optical view to show thermal channel, visible light channel, or both them combined. For thermal view, you can set the palettes.



FIGURE 2-10. PALETTES SETTINGS

1. In the live view interface, press the  button to display the palettes menu.
2. Press the  button to switch the view mode.





TABLE 2-3. PALETTES

PALETTES	DESCRIPTION
Thermal	In thermal mode, the device displays the thermal view. Press the  button to switch between White Hot and Black Hot mode.
Visible	In visible mode, the device displays the view of visible light channel.
Fusion B/W	It displays the combined view of thermal channel and optical channel in black and white.
City	Applicable to city environment.
Jungle	Applicable to jungle environment.
Desert	Applicable to desert environment.
Sea	Applicable to sea environment.
Snow	Applicable to snow environment.

After setting the palette, the current palette, next palette, and the previous palette are shown in the upper right corner.





2.5 WI-FI FUNCTION

Connect your phone or pad to the binoculars via Wi-Fi, you can configure the parameters and realize functions of the device.

1. Hold the  button to show the menu of binoculars.
2. Press the  button and  button to move the cursor to **Wi-Fi** submenu.
3. Press the  button to switch Wi-Fi ON or OFF.
4. Search the **T-Vision** (V5.4.12 and below) software on App Store (iOS System) or GooglePlay™ (Android) . Download and install the app to your phone.
5. Turn on the WLAN of your phone and connect to the hotspot. If the device is inactivated, set the password and activate it. If the device is activated, enter the password to add it to app.
 - Hotspot Name: Wlan-Serial No.
 - Hot Spot Password: Serial No.
6. Open the APP and connect your phone with the device.

When the device is added, the live view can be seen. You can view the interface of the binoculars on the software. User can change such image parameters as brightness, contrast, zoom, palettes directly via phone or pad as well as record video on phone/pad memory.

2.6 GPS FUNCTION

1. Hold the  button to show the menu of binoculars.
2. Press the  button and  button to move the cursor to **GPS** submenu.
3. Press the  button to switch ON or OFF.

2.7 CAPTURE SETTINGS







2.7.1 CAPTURE SNAPSHOTS

In the live view mode, press the  button to capture a snapshot.

When capturing succeeded, it shows **Capture succeeded**.

When capturing failed, it shows **Capture failed**.







2.7.2 VIDEO PLAYBACK

1. Hold the  button to show the menu of binoculars.
2. Press the  button and  button to move the cursor to **File>Image** submenu.
3. Press the  button to confirm.
4. Press the  button and  button to select snapshot.
5. Press the  button to play the selected snapshot.

2.7.3 DELETE SNAPSHOTS

ATTENTION:



Once a snapshot is deleted, it can **NOT** be recovered. Do this operation with attention.

1. Hold the  button to show the menu of binoculars.
2. Press the  button and  button to move the cursor to **File>Image** submenu.
3. Press the  button to confirm.
4. Press the  button and  button to select snapshot.
5. Hold the  button to delete the selected snapshot.







You can also delete the snapshot while viewing the live view.

2.8 VIDEO SETTINGS

2.8.1 VIDEO RECORDING

1. In the live view mode, hold the  button to record videos.
When the recording time shows on the top, it starts to record.
2. When the desired video is recorded, hold the  button to stop recording.







2.8.2 VIDEO PLAYBACK

1. Hold the  button to show the menu of binoculars.
2. Press the  button and  button to move the cursor to **File>Video** submenu.
3. Press the  button to confirm.
4. Press the  button and  button to select video.
5. Press the  button to play the selected video.

2.8.3 DELETE VIDEO







ATTENTION:

Once a video is deleted, it can NOT be recovered. Do this operation with attention.

1. Hold the  button to show the menu of binoculars.
2. Press the  button and  button to move the cursor to **File>Video** submenu.
3. Press the  button to confirm.
4. Press the  button and  button to select video.
5. Hold the  button to delete the selected video.

2.9 RESET DEFAULT SETTINGS

Restore the device to default settings.

1. Hold the  button to show the menu of binoculars.
2. Press the  button and  button to move the cursor to **Settings** submenu.
3. Press the  button to confirm.
4. Press the  button and  button to move the cursor to **Reset** submenu.
5. Press the  button to confirm.

3 MAINTENANCE

3.1 MAINTENANCE

3.1.1 CLEANING PROCEDURES

1. Gently brush off any dirt from the body of the device using a clean, soft cloth.
2. Moisten the cloth with fresh water and gently wipe down the external surfaces (except lenses).
3. Dry any wet surfaces (except lenses) using another dry, clean, soft cloth.
4. Using a lens brush, carefully remove all loose dirt from the lenses.
5. Dampen a cotton swab with ethanol and slowly, gently wipe down the lenses. Clean the glass surfaces using circular movements, starting from the center of the lens and moving out towards the edge, without touching the lens holder. Change the cotton swab after each circular stroke. Repeat this step until the glass surfaces are clean.
6. Clean the accessories with a soft brush (or cloth) dampened with soap and water.

3.1.2 PREPARING FOR EXTENDED STORAGE

CAUTION:

Thoroughly dry each item before placing them into the storage case.

To prepare the binoculars for extended storage:

1. Clean the binoculars and accessories.
2. Place all items into the storage case.

3.2 TROUBLESHOOTING

Table 3-1 lists the most common malfunctions that may occur with your equipment. If the equipment malfunction is not corrected by the suggested actions, or a problem occurs that is not listed in this table, please contact AGM Global Vision's Customer Support center or your retailer.

TABLE 3-1. TROUBLESHOOTING

MALFUNCTION	CORRECTIVE ACTION
The binoculars fails to activate.	<ol style="list-style-type: none">1. Batteries are missing or improperly installed: Insert batteries or install correctly.2. Low Battery: Charge the batteries.3. Batteries, surfaces, or contacts are dirty or corroded: Clean the contact surfaces with a pencil eraser and/or alcohol and cotton swabs.
The image of the binoculars is not clear.	<ol style="list-style-type: none">1. Objective lens and eyepieces not focused: Adjust the diopters and focus.2. Objective lens and eyepieces are dirt or fogged: Clean the lenses as detailed in Part 3.1.1.
Wi-Fi is not found.	Wi-Fi function is turned off: Turn on Wi-Fi function in the menu.
Capturing or recording fails.	<ol style="list-style-type: none">1. Storage space is full: Delete files to free up space.2. Device is low-battery: Charge the batteries.
No image on an external monitor.	The cable is damaged: Replace the cable with a new one.
The PC cannot identify the binoculars.	Examine the items below: <ol style="list-style-type: none">1. Whether the device is connected to your PC with standard USB cable.2. If you use other USB cables, make sure the cable length is no longer than 1 m.

4 WARRANTY INFORMATION

4.1 WARRANTY INFORMATION AND REGISTRATION

4.1.1 WARRANTY INFORMATION

This product is guaranteed to be free from manufacturing defects in material and workmanship under normal use for a period of three (3) years from the date of purchase. In the event that a defect covered by the warranty below occurs during the applicable period stated above, AGM Global Vision, at its discretion, will either repair or replace the product; such action on the part of AGM Global Vision shall be the full extent of AGM Global Vision's liability, and the Customer's sole and exclusive reparation. This warranty does not cover a product if it has been (a) used in ways other than its normal and customary manner; (b) subjected to misuse; (c) subjected to alterations, modifications or repairs by the Customer or by any party other than AGM Global Vision without prior written consent of AGM Global Vision; (d) is the result of a special order or categorized as "close-out" merchandise or merchandise sold "as-is" by either AGM Global Vision or the AGM Global Vision dealer; or (e) merchandise that has been discontinued by the manufacturer and either parts or replacement units are not available due to reasons beyond the control of AGM Global Vision. AGM Global Vision shall not be responsible for any defects or damage that in AGM Global Vision's view are a result from the mishandling, abuse, misuse, improper storage or improper operation of the device, including use in conjunction with equipment that is electrically or mechanically incompatible with, or of inferior quality to, the product, as well as failure to maintain the environmental conditions specified by the manufacturer. This warranty is extended only to the original purchaser. Any breach of this warranty shall be enforced unless the customer notifies AGM Global Vision at the address noted below within the applicable warranty period.

The customer understands and agrees that except for the foregoing warranty, no other warranties written or oral, statutory, expressed or implied, including any implied warranty of merchantability or fitness for a particular purpose, shall apply to the product. All such implied warranties are hereby and expressly disclaimed.

4.1.2 LIMITATION OF LIABILITY

AGM Global Vision will not be liable for any claims, actions, suits, proceedings, costs, expenses, damages, or liabilities arising out of the use of this product. Operation and use of the product are the sole responsibility of the Customer. AGM Global Vision's sole undertaking is limited to providing the products and services outlined herein in accordance with the terms and conditions of this Agreement. The provision of products sold and services performed by AGM Global Vision to the Customer shall not be interpreted, construed, or

regarded, either expressly or implied, as being for the benefit of or creating any obligation toward any third party of legal entity outside AGM Global Vision and the Customer; AGM Global Vision's obligations under this Agreement extend solely to the Customer. AGM Global Vision's liability hereunder for damages, regardless of the form or action, shall not exceed the fees or other charges paid to AGM Global Vision by the customer or customer's dealer. AGM Global Vision shall not, in any event, be liable for special, indirect, incidental, or consequential damages, including, but not limited to, lost income, lost revenue, or lost profit, whether such damages were foreseeable or not at the time of purchase, and whether or not such damages arise out of a breach of warranty, a breach of agreement, negligence, strict liability, or any other theory of liability.

4.1.3 PRODUCT REGISTRATION

In order to validate the warranty on your product, the customer must complete and submit AGM Global Vision PRODUCT REGISTRATION FORM on our website (www.agmglobalvision.com/customer-support).

4.1.4 OBTAINING WARRANTY SERVICE

To obtain warranty service on your unit, the End-user (Customer) must notify the AGM Global Vision service department via e-mail. Send any requests to support@agmglobalvision.com to receive a Return Merchandise Authorization number (RMA). When returning any device, please take the product to your retailer, or send the product, postage paid and with a copy of your sales receipt, to AGM Global Vision's service center at the address listed above. All merchandise must be fully insured with the correct postage; AGM Global Vision will not be responsible for improper postage or merchandise that becomes lost or damaged during shipment. When sending product back, please clearly write the RMA# on the outside of the shipping box. Please include a letter that indicates your RMA#, the Customer's Name, a Return Address, reason for the return, contact information (valid telephone numbers and/or an e-mail address), and proof of purchase that will help us to establish the valid start date of the warranty. Product merchandise returns that do not have an RMA# listed may be refused, or a significant delay in processing may occur. Estimated Warranty service time is 10-20 business days. The End-user/Customer is responsible for postage to AGM Global Vision for warranty service. AGM Global Vision will cover return postage/shipping after warranty repair to the End-user/Customer only if the product is covered by the aforementioned warranty. AGM Global Vision will return the product after warranty service by domestic UPS Ground service and/or domestic mail. Should any other requested, required, or international shipping methods be necessary, the postage/shipping fee will be the responsibility of the End-user/Customer.

For service, repair or replacement, please contact:

AGM Global Vision

173 West Main Street

PO Box 962

Springerville, AZ 85938

Tel. 928.333.4300

Fax 480.393.4882

support@agmglobalvision.com

www.agmglobalvision.com

5 SPECIFICATIONS

5.1 SPECIFICATIONS

Thermal Module	
Image sensor	Uncooled Focal Plane Arrays
Max. Resolution	640×512 @ 25 fps
Pixel Pitch	17 μm
Response waveband	8 μm to 14 μm
NETD	< 40 mk (@25°C, F#=1.0)
Lens (focal length)	50 mm, Manual focus
MRAD (IFOV)	0.34
Field of View	12.42° × 9.95°
Aperture	F 1.0
Digital Zoom	4×
Optical Module	
Image Sensor	1/3" Progressive Scan CMOS
Min. Illumination	B/W : 0.001 lux @ (F1.0 , AGC On)
Max. Resolution	1280×960 @ 25fps
Lens (focal length)	12 mm
Image Enhancement	3D DNR, Adaptive AGC
Image Display	
Monitor	0.39-inch, OLED, 1024 ×768
Thermal/Optical Mode	Thermal view, B/W optical view, image fusion view are selectable
Image Fusion	Color fusion, B/W fusion
Palettes	Black hot, white hot

Smart Functions	
Hot Track	Yes
Object Highlight	Yes
Cursor Display	A cursor shows in the view for roughly measuring distance from the target
Automatic Backlight	The OLED backlight automatically turns off if no human eyes are detected
System	
Storage	Built-in memory module (32GB)
Record Video	On-board video recording
Snapshot	On-board image capturing
Video Replay	Yes
Picture Search	Yes
Wi-Fi	Yes
GPS	Yes
Power Supply	
Battery Type	Four 18650 batteries, requires 5 hours to be fully charged
Battery Operating Time	≥7h
Battery Capacity Display	Yes
General	
Power	5V DC/2A
Working Temperature	-30°C to 55°C (-22°F to 131°F)
Protection level	IP67
Mounting	UNC 1/4"-20
Cable Output	Aviation plug: connecting to BNC, DB9, and USB
Accessories (Supplied)	Battery charger, battery charger power cable, wiping cloth, two wrist straps, User manual, aviation plug cable, eight batteries
Dimension (L x W x H)	164 mm × 182.3 mm × 73.3 mm (6.46" × 7.18" × 2.89")
Weight	<1.0 kg (2.20 lb)

**All data subject to change without notice.*

NOTES



AGM Global Vision

MAIN OFFICE

173 West Main Street

PO Box 962

Springerville, AZ 85938

USA

Tel. +1.928.333.4300

Fax +1.480.393.4882

info@agmglobalvision.com

www.agmglobalvision.com

EUROPEAN OFFICE

Andrey Lyapchev #7

Sofia, P.C. 1756

Bulgaria

Tel. +44.292.255.0509

info@agmglobalvision.eu

www.agmglobalvision.eu