



# ECLIPSE *Ci/Ni*

Upright Microscope



# Feel the evolution

Nikon developed the clinical and laboratory microscope ECLIPSE Ci series to meet the demands of a microscope that provides comfortable posture during observation and simple set-up, such as magnification switching, light intensity reproduction and image capturing. With its small footprint, the Ci series delivers compact and space-saving observation conditions. Nikon also developed the ECLIPSE Ni series, which offers high optical quality and a wide range of imaging possibilities. The highly-evolved Ci/Ni series microscopes enable routine analysis with more comfort and greater flexibility than ever before.

## ECLIPSE Ci

- **Eco Friendly**  
High-intensity, long-life and power saving illumination
- **Ergonomic**  
Flexible, adjustable design to suit the user's natural posture
- **Easy to Use**  
One-touch operation for microscope\* control and image capturing
- **Versatile**  
Flexible observation with a wide range of specimens

\*Ci-E

## ECLIPSE Ni

- **High-quality**  
Superior optical performance
- **Expandability**  
Wide variety of optional motorized accessories
- **Automation\***  
Intelligent, automatic switching of observation methods

\*Ni-E

### ● Meeting user needs in clinical microscopy

I want to easily capture images.

I want to conduct observation in comfort.

I want to observe images with bright and even illumination.

I want to simplify operation with motorized accessories.

I want to use a variety of observation techniques.

I want to reduce the number of lamp replacements.

## The Ci meets all your demands.

The ECLIPSE Ci series microscopes offer a bright field of view, high durability, comfortable posture for prolonged observation, simple motorized operation, and various illumination techniques that you need for clinical and laboratory microscopy.

### Eco Friendly

- **Eco-illumination (Ci-E/Ci-L)**

Nikon's unique high luminescent LED is a low power consumption eco-friendly light source that produces evenly distributed illumination and reduces the cost and effort of lamp replacement thanks to its long-life.

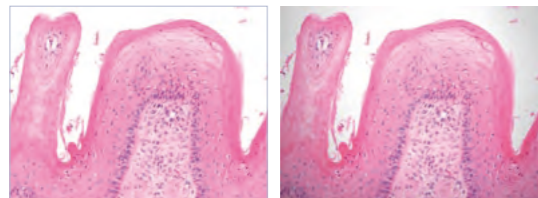

Viewed with Eco-illumination

Viewed without Eco-illumination

\*These images are captured without using the shading compensation to emphasize the vignetting.

- **Ceramic-coated stage**

The stage is coated with high durability scratch-resistant coating.



### Ergonomic

- **Ergonomic binocular tube**

Eyepiece angle and extension are adjustable. A camera can be mounted via the DSC port.



Ergonomic binocular tube

- **Eyelevel riser**

Eye-point height can be adjusted to suit your natural posture and increases flexibility for multi-users of different heights.

- **Lower stage positioning**

Lower stage height using the nosepiece spacer for easy specimen exchange.



Nosepiece spacer

- **Stage handle with height adjustment**

Smooth stage movement is possible in a comfortable hand position.

### Easy to use

- **Image capture button**

One simple click of the button during observation enables you to capture your specimen image with the Digital Sight camera.



- **Motorized magnification change (Ci-E)**

Magnification can be switched with one button control during observation, which automatically memorizes and reproduces user-defined light intensity.



- **NIS-Elements L Imaging Software**

Images/movies can be easily acquired and stored using a tablet PC. A scene mode function, which provides easy camera settings, and simple measurement functions are also provided.



### Versatile

- **Flexible observation methods**

The high-intensity Eco-illumination and accessories enable you to perform phase contrast, darkfield and simple polarizing microscopy.

- **Image sharing**

The live image can be displayed on the tablet PC monitor or via a projector.

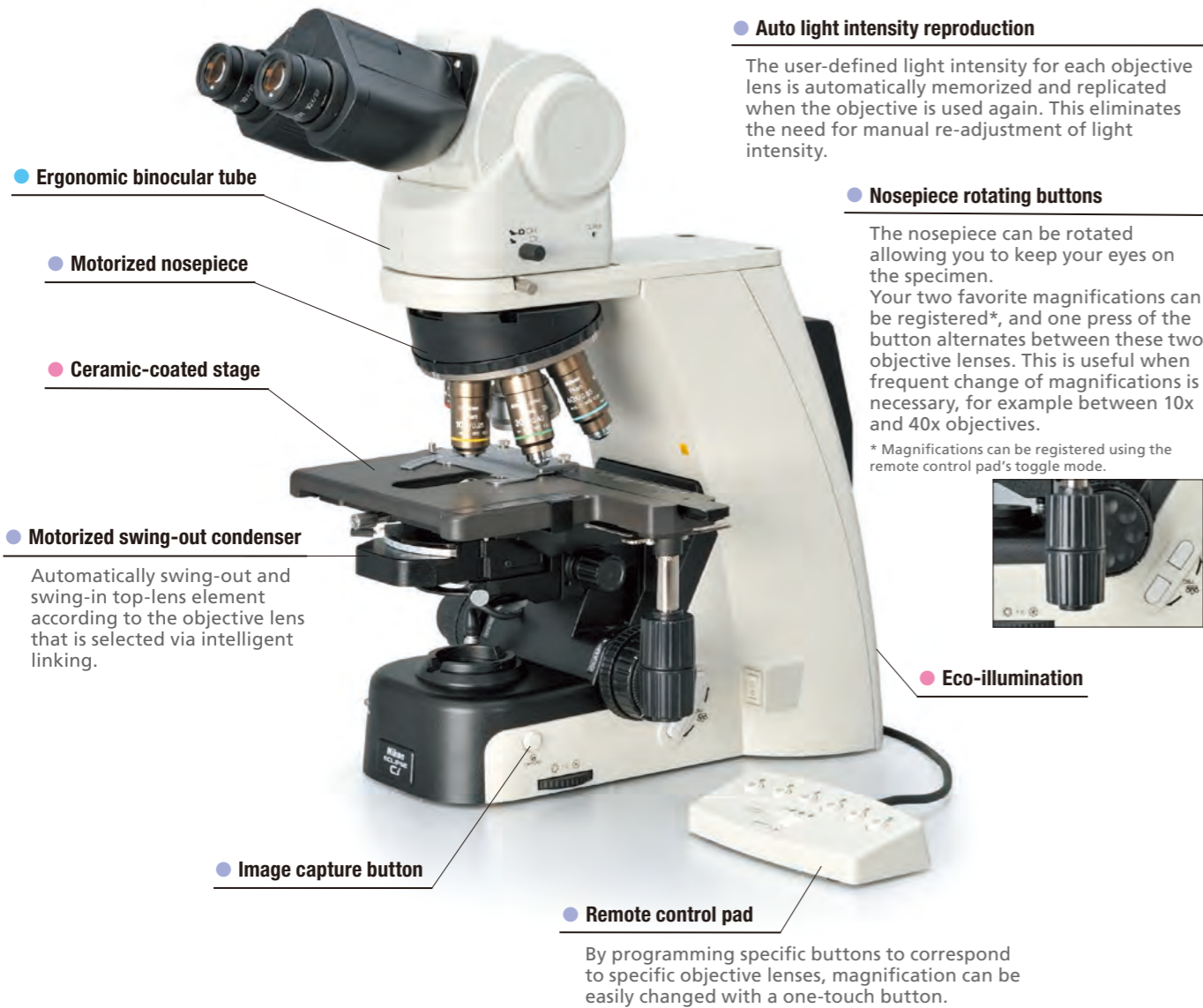

## Provides streamlined observation with motorized operation

### Motorized model with LED illumination

Equipped with motorized magnification switching and automatic intensity reproduction, it is ideally suited to applications and sample analysis that require frequent magnification switching.

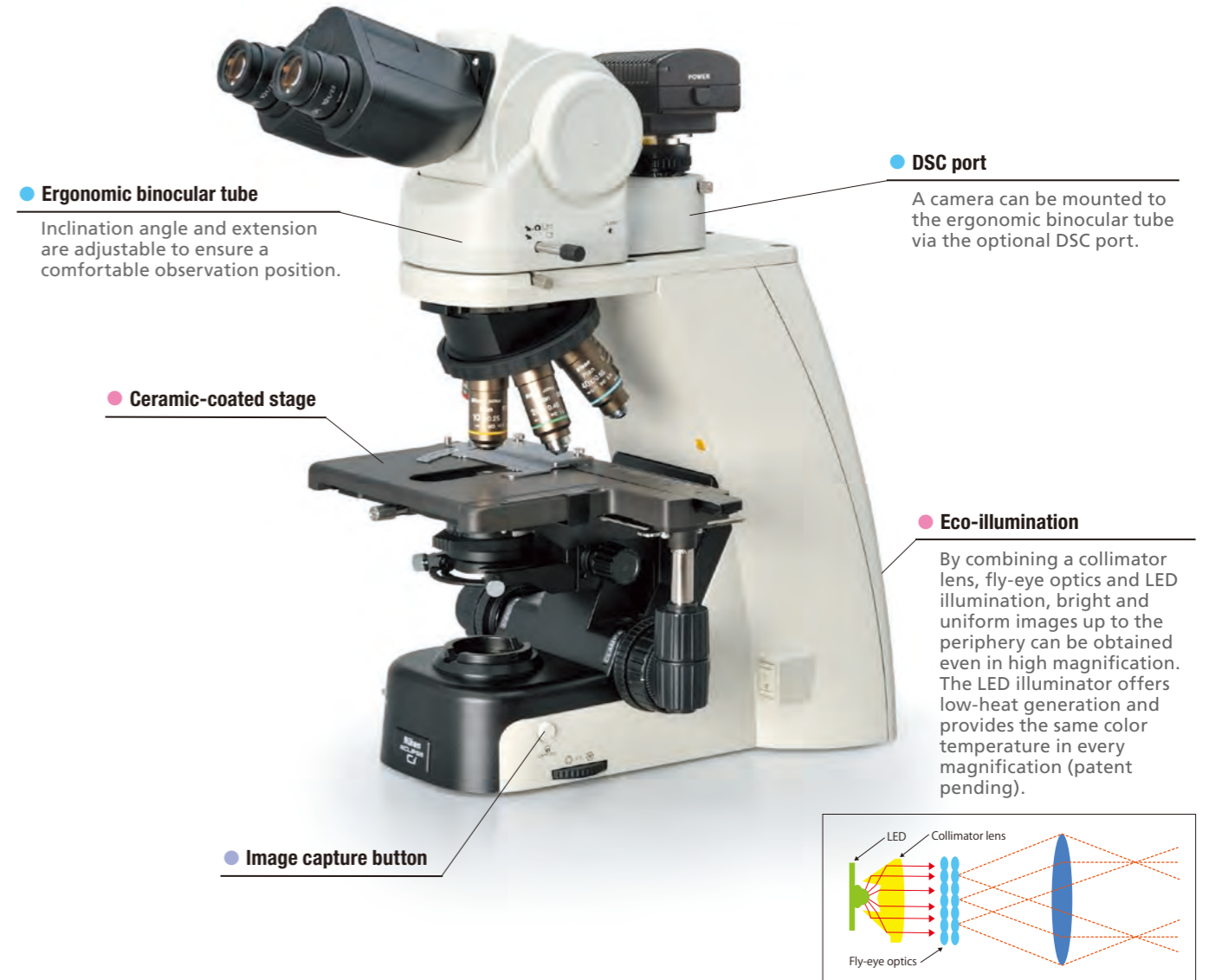

## High-intensity and uniform Eco-Illumination

### Manual model with LED illumination

Featuring Eco-illumination bright enough for phase contrast and simple polarizing microscopy while reducing lamp replacement with a long-life of 60,000 hours.



● Ergonomic binocular tube

● Ceramic-coated stage

The stage is coated with an abrasion and chemical-resistant ceramic coating, allowing long-term frequent specimen changes without damaging the stage surface.

● Image capture button

● Space-saving compact design

The compact body with an extremely small footprint gives the user more desk space than ever.

● Halogen illumination

● ND4/ND8 filter, NCB11 filter

Changing light intensity is possible by inserting and removing an ND (Neutral Density) filter. The NCB filter for color temperature compensation of the light source is built-in.

## Enhanced basic performance for observation

Manual model with halogen illumination

With a small footprint and superior operability the ECLIPSE Ci series offers a comfortable, ergonomic viewing position.

## Versatile observation techniques

Using accessories, the Ci-E, Ci-L and Ci-S enable various observation techniques to meet the demands of a wide range of uses, from clinical examination to research.

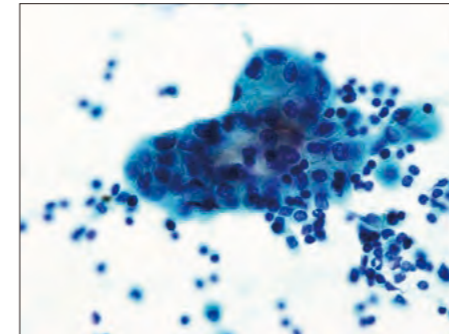

Breast Cancer, Pleural effusion, Papanicolaou stain, CFI Plan Apochromat Lambda 60XC 1

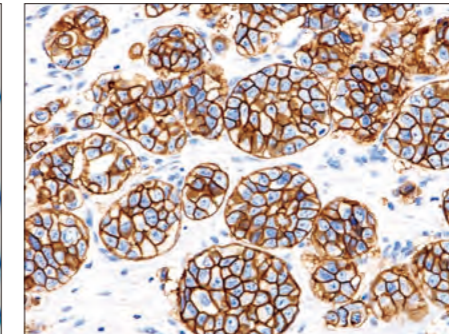

Breast Cancer, HER2/neu, Immunostaining, CFI Plan Apochromat Lambda 40XC 2

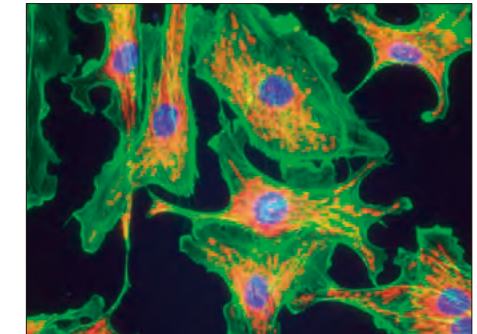

Epi-fluorescence

1 2 Photos courtesy of: Dr. Yoji Urata, Department of Diagnostic Pathology, Japanese Red Cross Kyoto Daiichi Hospital

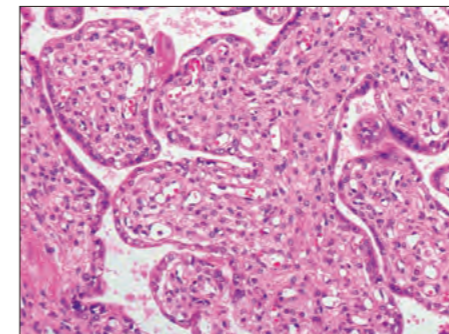

Human Placenta, HE stain, CFI Plan Apochromat Lambda 10X 3

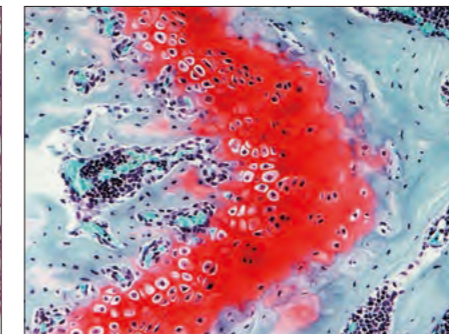

Cartilage of mouse femur, Safranin O fast green iron hematoxylin stain, CFI Plan Apochromat Lambda 10X 4

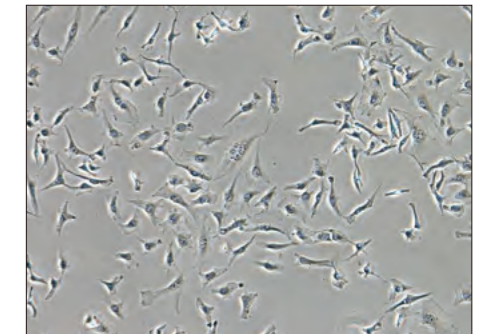

Phase contrast

3 4 Photos courtesy of: Dr. Atsushi Furuhashi and Noriyoshi Sueyoshi, Assistant General Manager, Laboratory of morphology and image analysis, Graduate School of Medicine, Juntendo University

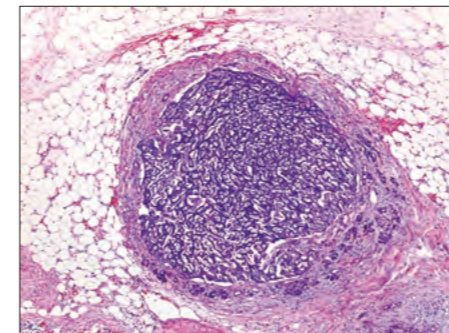

Pancreas Neuro-endocrine Tumor, HE stain, CFI Plan Apochromat Lambda 4X 5

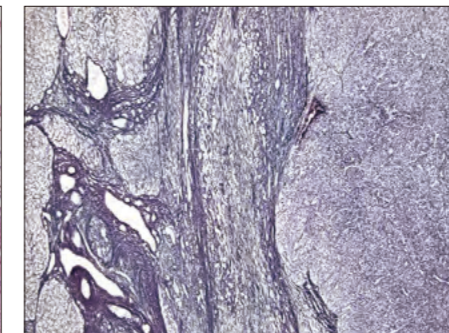

HCC, Silver stain, CFI Plan Apochromat Lambda 4X 6

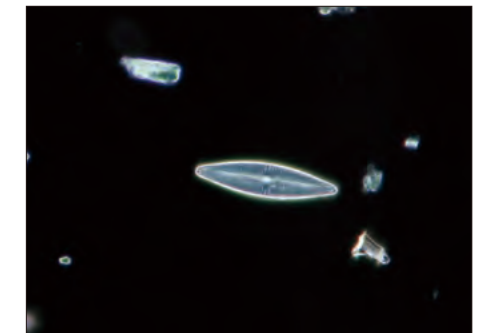

Darkfield

5 6 Photos courtesy of: Kazuhiro Muraoka, Photography Division, Imaging Information Research Center, Tokyo Women's Medical University

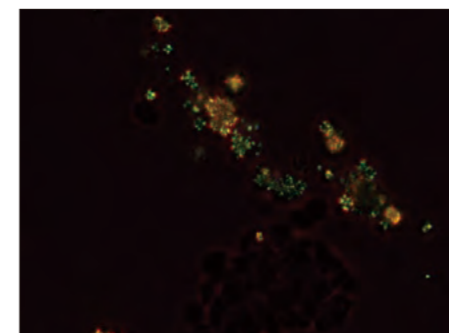

2,8-Dihydroxyadenine crystals, Simple polarizing, CFI Plan Fluor 40X 7

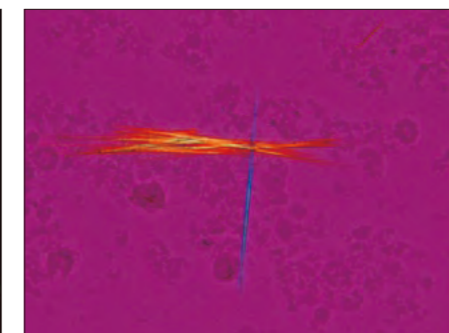

Sodium urate crystals, Sensitive color polarizing, CFI Plan Fluor 40X 8

7 8 Photos courtesy of: Department of Clinical laboratory, Nihon University Itabashi Hospital

# Digital imaging evolved

In response to user demand for the easy capture of sample images, the ECLIPSE Ci series has a built-in dedicated capture button on the microscope base. An optional imaging software supports simple camera settings and operation including capturing and measuring.

## Image capture button

Image capturing with the digital camera Digital Sight series is possible with the one-touch button located on the microscope base, thereby improving workload efficiency.



## NIS-Elements L imaging software



The NIS-Elements L imaging software featuring simple and user-friendly GUI allows easy camera setting and image capturing using DS-Ri2 and DS-Fi3 microscope cameras.

- Enables easy image acquisition and storage using a tablet PC\*, facilitating effective sharing of images and presentations. Also supports touch screen operation.
- Movie recording time is approximately 30 minutes.
- Scene modes function provides the appropriate camera setting for each sample.
- Split-screen display function allows comparison between live and saved images.
- Simple measurement functions for length, area and angles.
- Graticule scale display such as hairline and grid.
- Annotation function enables the addition of arrows and markers to images.
- During observation, live and captured images can be shared on a large screen monitor or projector.

\* Nikon provides confirmed compatible tablet PCs with up-to-date specifications. Contact Nikon for details.



## Basic camera setting

Simple camera settings such as resolution, exposure and gain are possible.

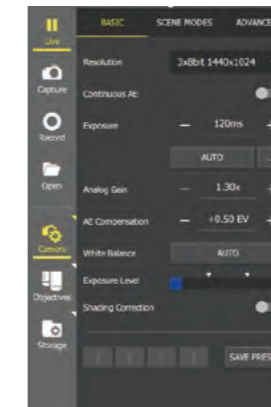

## Split-screen display

The split-screen display function enables real-time comparisons between live and captured images by displaying them side-by-side and synchronizing zooming between both images.

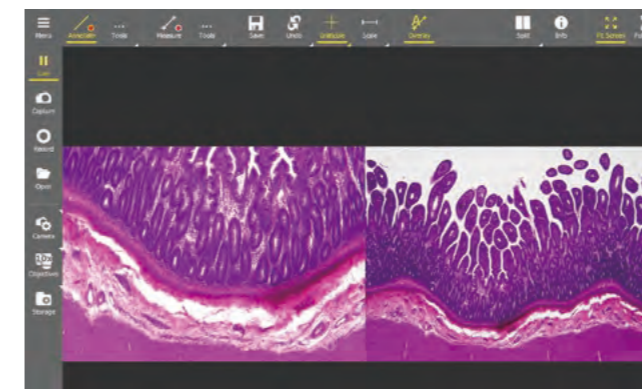

## Scene modes

The scene modes function enables the optimal camera setting for each sample and imaging technique by simply choosing the type of illumination or stain.

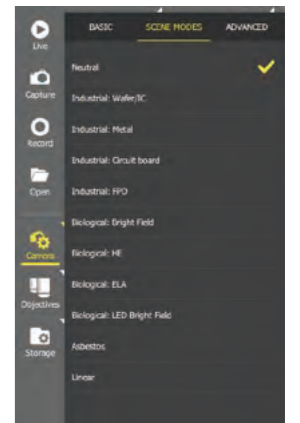

## Measurement

Simple measurement functions, such as distance measurement between two points, are available.

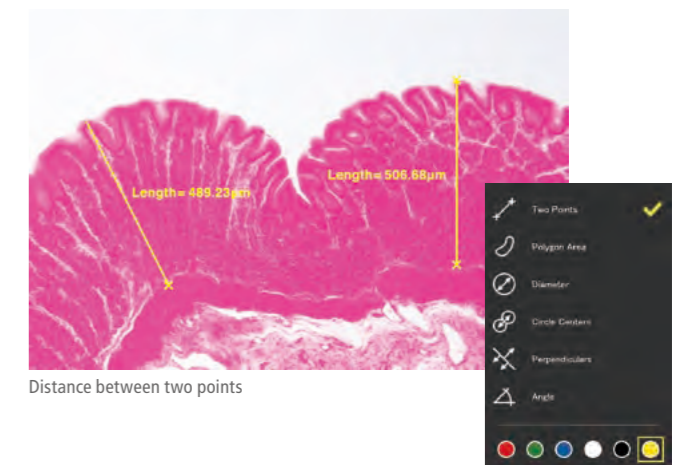

## Digital Sight series microscope cameras

Nikon provides digital cameras that are optimized for microscopic imaging. Users can select the most suitable camera for their samples and observation techniques.

### Microscope Camera DS-Fi3



5.9 megapixel  
Color  
High-definition

Equipped with a 5.9 megapixel CMOS image sensor. Enables fast and easy acquisition of images with superior color reproduction and high sensitivity during various observations, such as brightfield, DIC, phase contrast and epi-fluorescence.

### Microscope Camera DS-Ri2



16.25 megapixel  
Color  
High-definition

Equipped with FX-format 16.25-megapixel CMOS sensors, the DS-Ri2 is perfect for capturing ultra-fine structures. It enables brightfield imaging with superior color reproduction and fast frame rates, as well as high sensitivity fluorescent imaging.

# Ci accessories meet additional demands of users

## I want to observe using fluorescent microscopy.

The ECLIPSE Ci series has the option of two dedicated compact epi-fluorescence attachments, CI-FL Epi-fluorescence Attachment (4 filter cubes mountable) and D-FL Epi-fluorescence Attachment (6 filter cubes mountable).



## I want to use phase contrast microscopy with LED illumination.

Eco-illumination has sufficient light intensity for phase contrast microscopy that is used in a wide range of applications including dermatological examinations.



Phase contrast accessories

## I want to observe the same view field simultaneously with another person

The teaching head enables multiple peoples to observe the same specimen simultaneously. A bright and long-life LED is employed in the pointer.

\* 3-person type and 5-person type are also available.



Side-by-side type

Face-to-face type

## I want more user-friendly stage operation.

The stage height can be lowered 20mm from the standard position by adding a nosepiece spacer, facilitating frequent specimen change.

The stage handle height can be changed to ensure a comfortable hand position.



Without spacer

With spacer



## I want to observe specimens with a wider field of view.

Attaching the CFI UW 10X eyepiece lens with an F.N. of 25mm in combination with a trinocular tube T and trinocular tube F enables wide field microscopy.

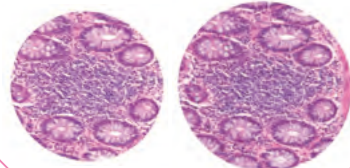

22mm

25mm

## I want to perform gout tests.

Eco-illumination is compatible with sensitive color polarizing microscopy, and gout tests can be conducted by observing uric acid crystals.



Sensitive color polarizing accessories

## I want to reduce the number of times I switch the condenser.

An optional achromat swing-out condenser is compatible with a wide range of magnifications, between 1X to 100X.



## I want to be able to quickly and safely change the specimen.

The stage height can be locked using the re-focusing knob, and this facilitates safe refocusing after changing the specimen.

## I want to easily capture digital images of my specimens.

You can mount a camera on a trinocular tube T, trinocular tube F or an ergonomic binocular tube. Imaging in a comfortable position is possible with an ergonomic binocular tube by mounting the camera via the DSC port. Imaging is possible by simply pushing the image capture button.



Trinocular tube T

Trinocular tube F

Ergonomic binocular tube

## I want to undertake long-term observation with minimal discomfort.

The ergonomic binocular tube can be inclined from 10° to 30° and extended up to 40mm. The eyelevel riser lifts the tube in 25mm increments (up to 100mm\*).

\* Up to 50mm with ergonomic binocular tube.

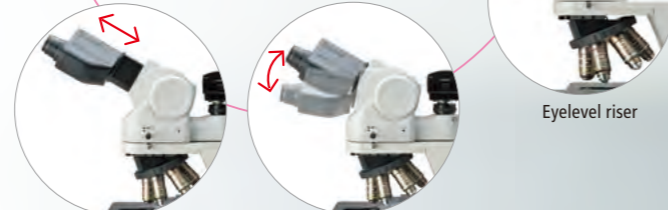

Eyelevel riser

## I want to use various objective lenses.

Nikon provides a broad range of objective lenses, such as the CFI Plan Achromat series, which is affordably priced and has high image flatness, the CFI Plan Fluor series, which is suitable for fluorescence microscopy, and the CFI Plan Apochromt Lambda series, with its superior resolution, brightness and chromatic aberration correction.



Left: CFI Plan Achromat series; middle: CFI Plan Fluor series; right: CFI Plan Apochromt Lambda series

# ECLIPSE Ni

## Two flagship upright microscopes

The newly developed upright microscope ECLIPSE Ni series has high expandability, motorization, and superior optical performance.

Ni-E is a fully motorized model provides the most suitable observation settings without manual adjustment. The aperture and field diaphragm or condenser is automatically adjusted when the magnification is changed.

Ni-U is suitable for many observations, from clinical examination to research, and featuring motorized accessories that include nosepiece, fluorescence attachment, and shutter.



Motorized model with automatic observation switching

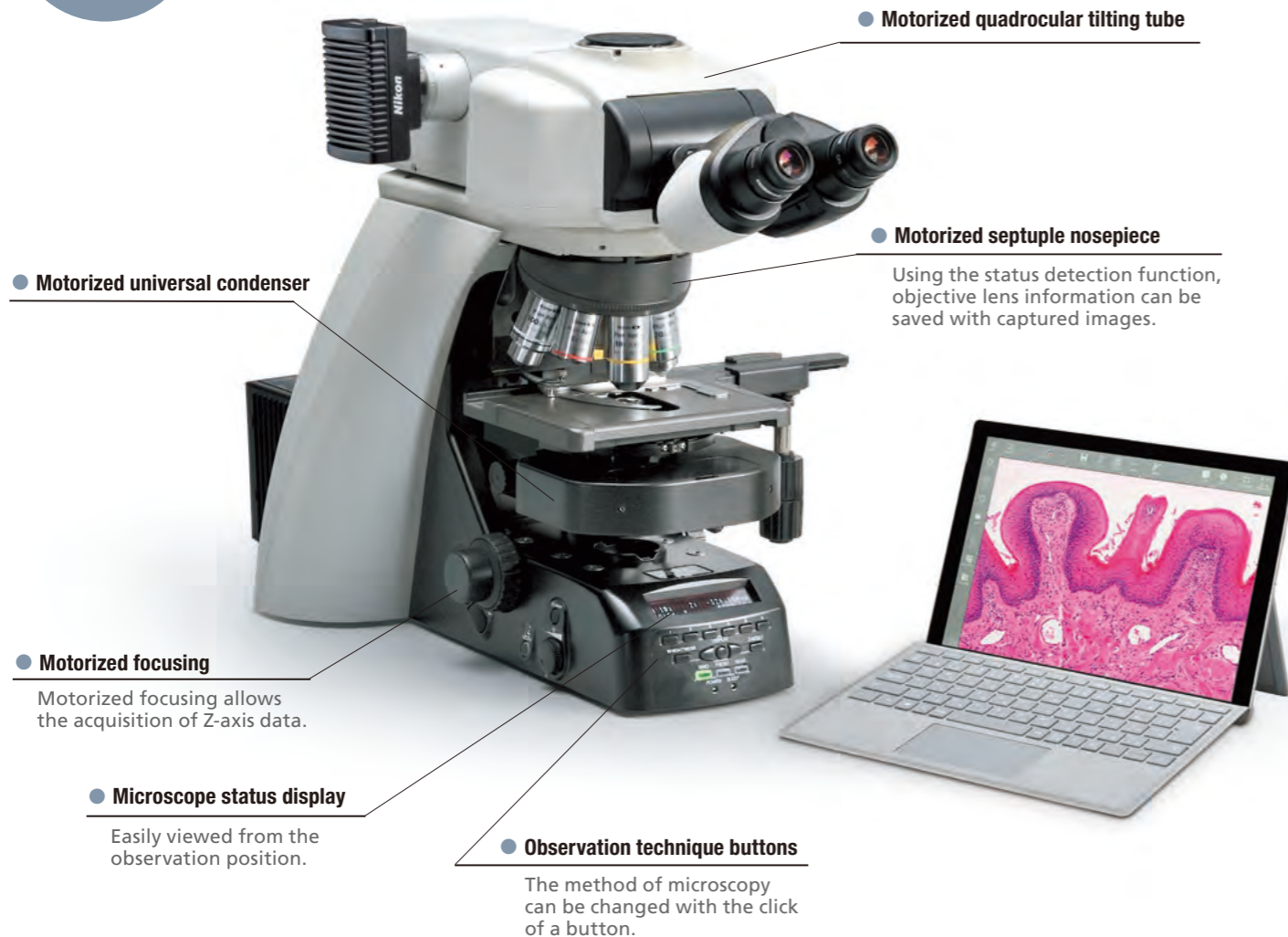

### ● Fly-eye optics

The fly-eye optics built into the transmitted-light illumination system provides bright and uniform illumination across the entire field of view.

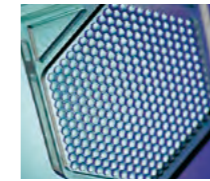

### ● Superior optical performance

Nikon offers high quality optical technologies such as exclusive low-reflective Nano Crystal Coat to produce objective lenses. The CFI Plan Apochromat Lambda series objective lenses offer remarkably high transmission and superior chromatic aberration correction throughout a broad range of wavelengths and are suitable for near-IR observation.



### ● Noise terminator

The noise terminator mechanism is equipped with fluorescent filter cubes and turrets that eliminate stray light, and enables you to capture high contrast fluorescence images with a high S/N ratio.

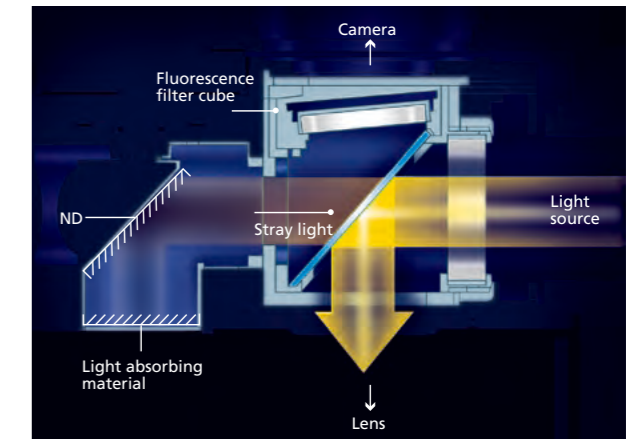

Manual model with motorization capability





# Ci System Diagram

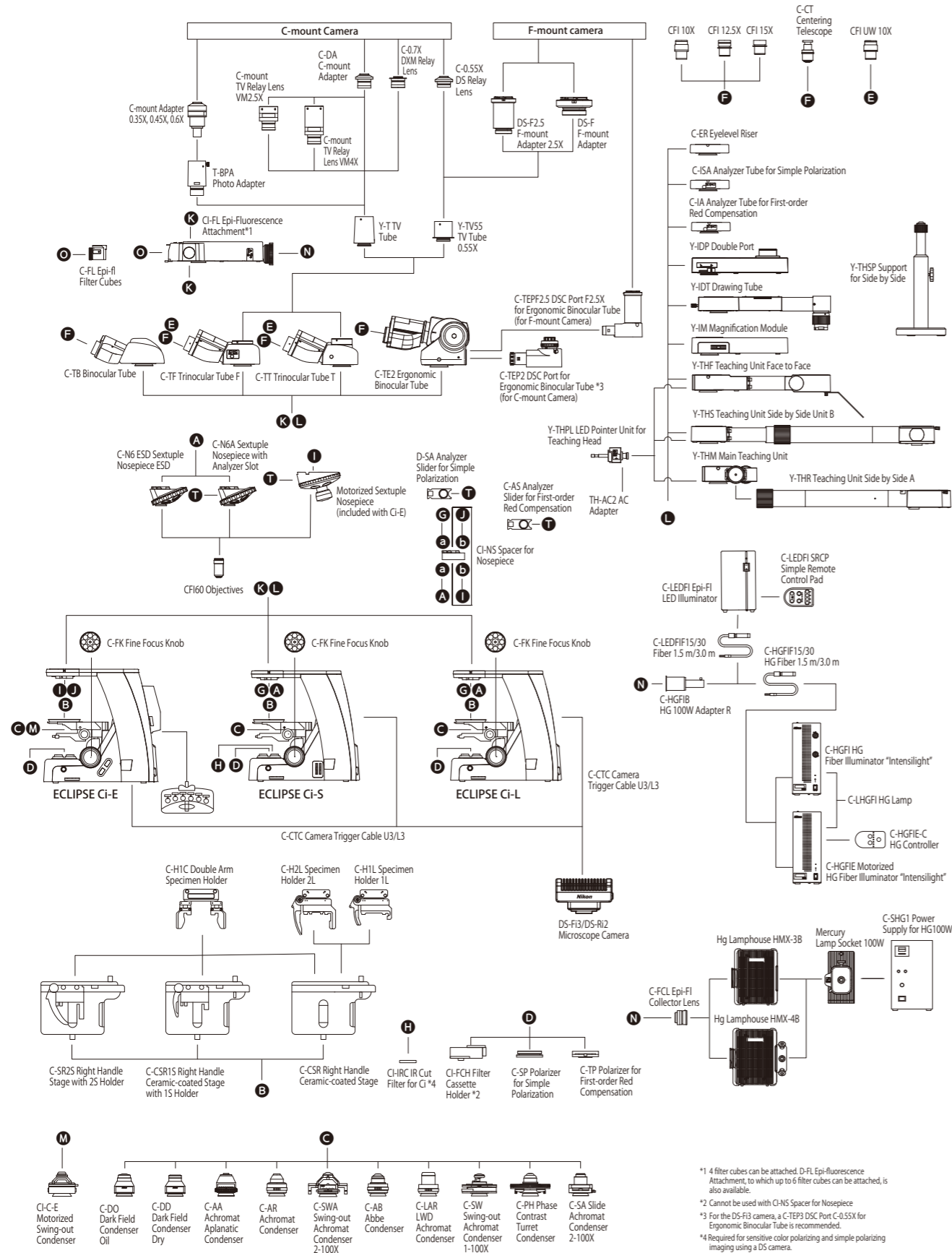

- C-CTC Camera Trigger Cable U3/L3
- C-H1C Double Arm Specimen Holder
- C-H2L Specimen Holder 2L
- C-H1L Specimen Holder 1L
- C-SR2S Right Handle Stage with 2S Holder
- C-CSR1S Right Handle Ceramic-coated Stage with 1S Holder
- C-CSR Right Handle Ceramic-coated Stage
- CHRC IR Cut Filter for CI\*4
- CI-FCH Filter Cassette Holder\*2
- C-SP Polarizer for Simple Polarization
- C-TP Polarizer for First-order Red Compensation
- C-CE Motorized Swing-out Condenser
- C-DO Dark Field Condenser Oil
- C-DD Dark Field Condenser Dry
- C-AA Achromat Aplanatic Condenser
- C-AR Achromat Condenser
- C-SWA Swing-out Achromat Condenser 2-100X
- C-AB Abbe Condenser
- C-LAR LWD Achromat Condenser
- C-SW Swing-out Achromat Condenser 1-100X
- C-PH Phase Contrast Turret Condenser
- C-SA Slide Achromat Condenser 2-100X

\*1 4 filter cubes can be attached. D-FL Epi-fluorescence Attachment, to which up to 6 filter cubes can be attached, is also available.  
 \*2 Cannot be used with C-NS Spacer for Nosepiece  
 \*3 For the DS-F13 camera, a C-TEP3 DSC Port C-0.55X for Ergonomic Binocular Tube is recommended.  
 \*4 Required for sensitive color polarizing and simple polarizing imaging using a DS camera.

# Specifications

		Ci-E	Ci-L	Ci-S
Main body	Optical system	CFI60 Infinity Optical System		
	Illumination	High luminescent White LED Illuminator (Eco-illumination)		6V30W Halogen Lamp Built-in ND4, ND8, NCB11 filters
		Automatic intensity reproduction function		—
	Controls	Image capture button		ND filter IN/OUT switches
Nosepiece rotating buttons Remote control pad		—		
Tubes	Eyepieces (F.O.V. mm)	· CFI 10X (22) · CFI 12.5X (16) · CFI 15X (14.5) · CFI UW 10X (25)		
		Focusing Coaxial Coarse/Fine focusing, Focusing stroke: 30 mm, Coarse: 9.33 mm/rotation, Fine: 0.1 mm/rotation Coarse motion torque adjustable, Refocusing function		
	F.O.V. 22 mm (Eyepiece/Port)	· C-TB Binocular Tube · C-TE2 Ergonomic Binocular Tube (100/0, 50/50 via optional C-TEP2 DSC Port, C-TEP3 DSC Port C-0.55X or C-TEPF2.5 DSC Port F2.5X) Inclination angle: 10-30 degree, Extension: up to 40 mm		
Nosepieces	· Motorized Sextuple Nosepiece with Analyzer Slot (Within main body) Switching between two objectives function		· C-N6 ESD Sextuple Nosepiece ESD · C-N6A Sextuple Nosepiece with Analyzer Slot	
	Stages Cross travel 78 (X) × 54 (Y) mm, with vernier calibrations, stage handle height and torque adjustable for all stages C-H1C Double Arm Specimen Holder is available as an option for the below three stages. · C-SR2S Right Handle Stage with 2S Holder · C-CSR1S Right Handle Ceramic-coated Stage with 1S Holder · C-CSR Right Handle Ceramic-coated Stage (C-H2L Specimen Holder 2L and C-H1L Specimen Holder 1L can be attached)			
Condensers (NA)	Motorized	· CI-C-E Motorized Swing-out Condenser (0.90/0.22) Focusing stroke: 27 mm		—
	Manual	Focusing stroke: 27 mm · C-AB Abbe Condenser (0.90) · C-AR Achromat Condenser (0.80) · C-DO Darkfield Condenser Oil (1.20-1.43) · C-DD Darkfield Condenser Dry (0.80-0.95) · C-PH Phase Contrast Turret Condenser (0.90) · C-AA Achromat/ Aplanat Condenser (1.40) · C-SA Slide Achromat Condenser 2-100X (0.90) · C-SW Swing-out Achromat Condenser 1-100X (0.90/0.11) · C-SWA Swing-out Achromat Condenser 2-100X (0.90/0.22) · C-LAR LWD Achromat Condenser (0.65)		
Observation methods*		Brightfield, Epi-fluorescence, Darkfield, Phase contrast, Simple polarizing, Sensitive color polarizing		
Epi-fluorescence attachment		· CI-FL Epi-fluorescence Attachment (4 filter cubes mountable) · D-FL Epi-fluorescence Attachment (6 filter cubes mountable) ND4/ND8/ND16 filters, Noise Terminator mechanism		
Epi-fluorescence light source		· C-LEDFI Epi-FI LED Illuminator · C-HGFI/HGFIE HG Precentered Fiber Illuminator Intensilight (130W) · Hg Lamphouse and Power Supply (100W)		
Power consumption		13W (Brightfield configuration)	6W (Brightfield configuration)	38W (Brightfield configuration)
Weight (approx.)		15.4 kg (Binocular standard set)	13.4 kg (Binocular standard set)	13.4 kg (Binocular standard set)

\*Observations except Brightfield require optional accessories.

# Dimensional Diagram

Unit: mm

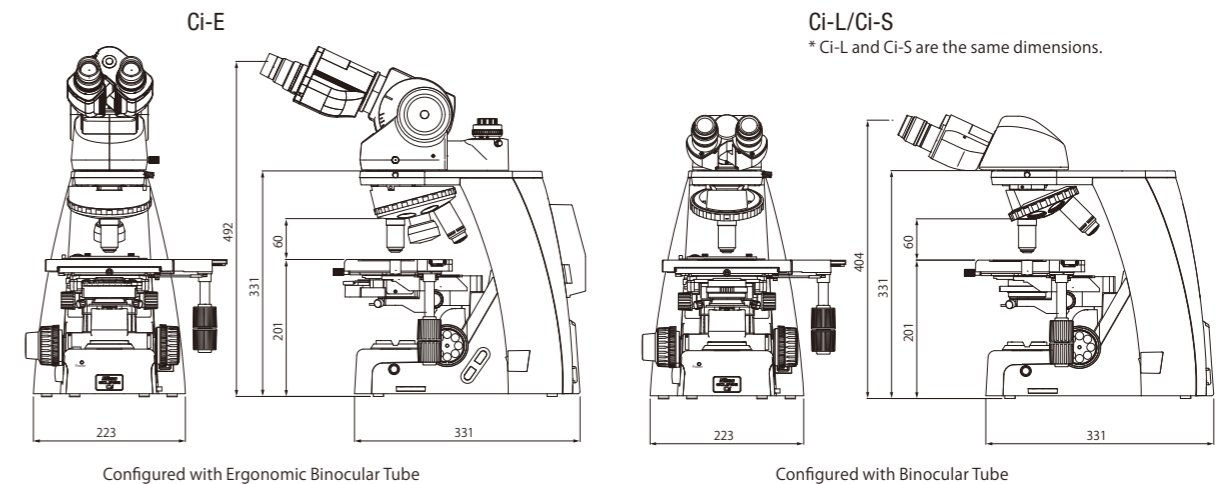

Configured with Ergonomic Binocular Tube

Configured with Binocular Tube

# Ni-E/U System Diagram

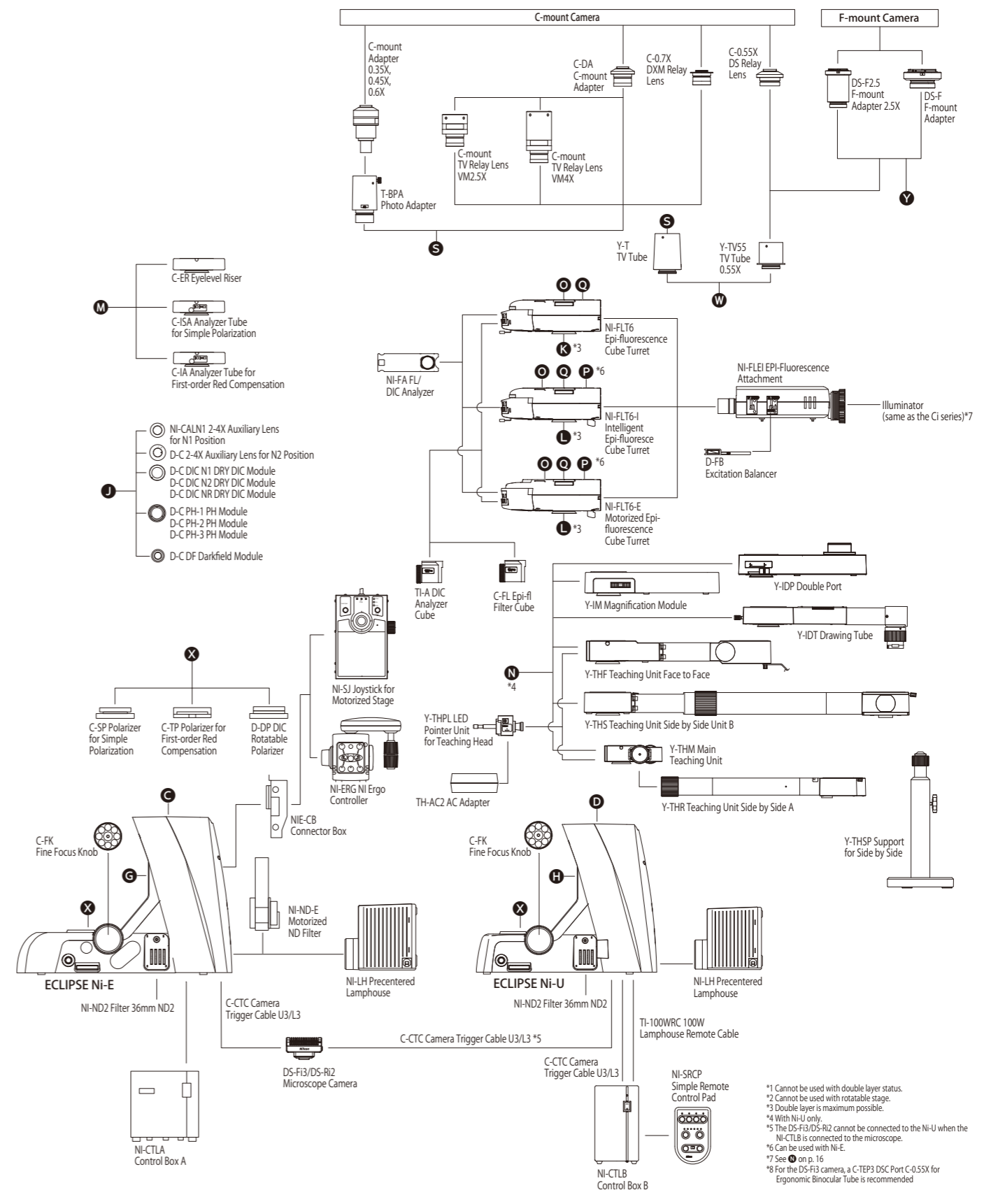
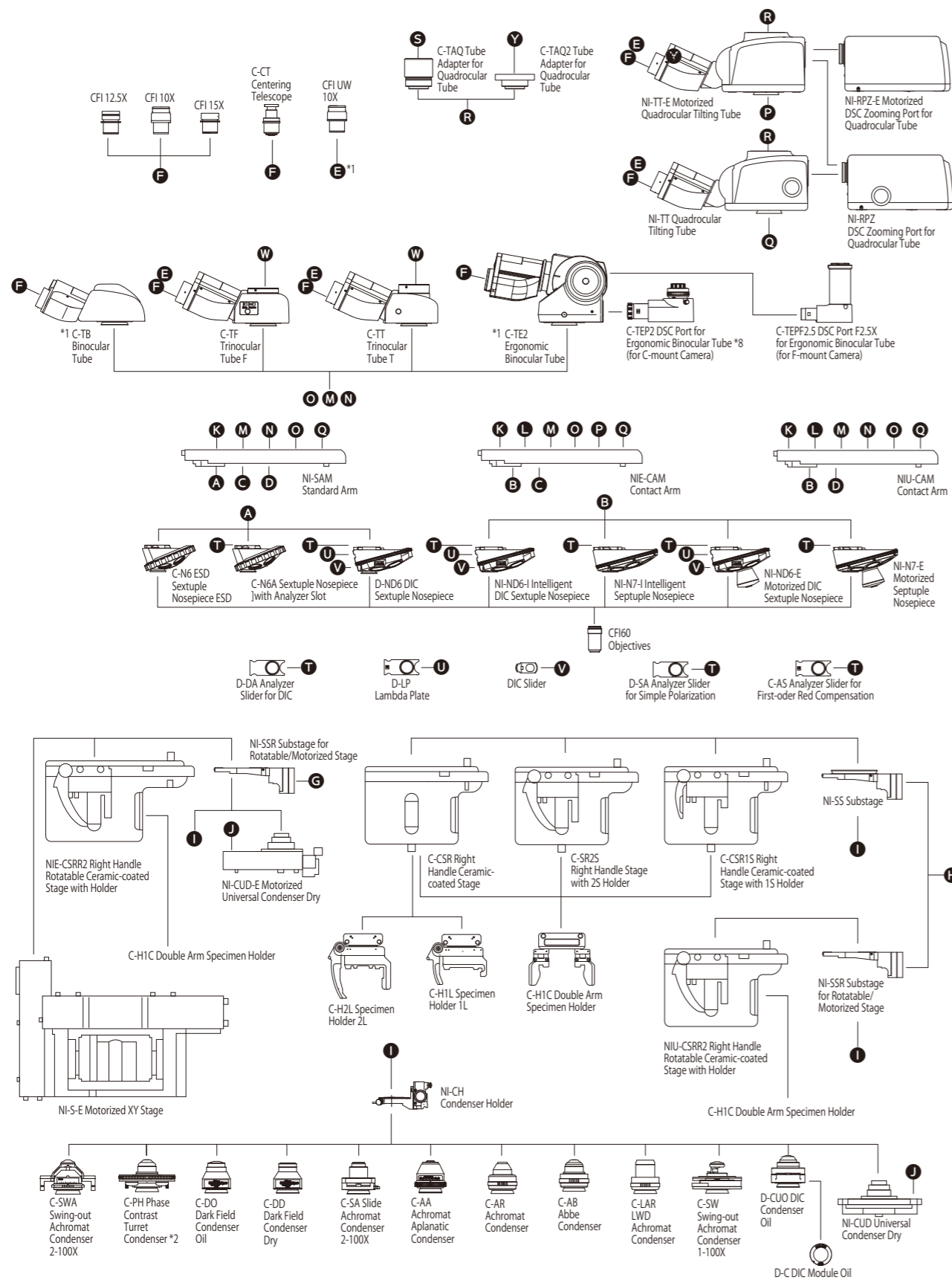

\*1 Cannot be used with double layer status.  
 \*2 Cannot be used with rotatable stage.  
 \*3 Double layer is maximum possible.  
 \*4 With Ni-U only.  
 \*5 The DS-F13/DS-R12 cannot be connected to the Ni-U when the Ni-CTLB is connected to the microscope.  
 \*6 Can be used with Ni-E.  
 \*7 See on p. 16  
 \*8 For the DS-F13 camera, a C-TEP3 DSC Port C-0.55X for Ergonomic Binocular Tube is recommended

Company names and product names appearing in this brochure are their registered trademarks or trademarks.  
N.B. Export of the products\* in this brochure is controlled under the Japanese Foreign Exchange and Foreign Trade Law.  
Appropriate export procedure shall be required in case of export from Japan.  
\*Products: Hardware and its technical information (including software)  
Monitor images are simulated.

Specifications and equipment are subject to change without any notice or obligation on the part of the manufacturer. January 2019 ©2011-19 NIKON CORPORATION

 **WARNING** TO ENSURE CORRECT USAGE, READ THE CORRESPONDING MANUALS CAREFULLY BEFORE USING YOUR EQUIPMENT.



**NIKON CORPORATION**

Shinagawa Intercity Tower C, 2-15-3, Konan, Minato-ku, Tokyo 108-6290, Japan  
phone: +81-3-6433-3705 fax: +81-3-6433-3785  
<https://www.healthcare.nikon.com/>

ISO 14001 Certified  
for NIKON CORPORATION

**NIKON INSTRUMENTS INC.**

1300 Walt Whitman Road, Melville, N.Y. 11747-3064, U.S.A.  
phone: +1-631-547-8500; +1-800-52-NIKON (within the U.S.A. only)  
fax: +1-631-547-0306

<https://www.microscope.healthcare.nikon.com/>

**NIKON INSTRUMENTS EUROPE B.V.**

Tripolis 100, Burgerweeshuispad 101, 1076 ER Amsterdam, The Netherlands  
phone: +31-20-7099-000 fax: +31-20-7099-298

[https://www.microscope.healthcare.nikon.com/en\\_EU/](https://www.microscope.healthcare.nikon.com/en_EU/)

**NIKON INSTRUMENTS (SHANGHAI) CO., LTD.**

CHINA phone: +86-21-6841-2050 fax: +86-21-6841-2060  
(Beijing branch) phone: +86-10-5831-2028 fax: +86-10-5831-2026  
(Guangzhou branch) phone: +86-20-3882-0550 fax: +86-20-3882-0580

**NIKON CANADA INC.**

CANADA phone: +1-905-602-9676 fax: +1-905-602-9953

**NIKON FRANCE S.A.S.**

FRANCE phone: +33-1-4516-45-16 fax: +33-1-4516-45-55

**NIKON GMBH**

GERMANY phone: +49-211-941-42-20 fax: +49-211-941-43-22

**NIKON INSTRUMENTS S.p.A.**

ITALY phone: +39-55-300-96-01 fax: +39-55-30-09-93

**NIKON GMBH SWITZERLAND**

SWITZERLAND phone: +41-43-277-28-67 fax: +41-43-277-28-61

**NIKON UK LTD.**

UNITED KINGDOM phone: +44-208-247-1717 fax: +44-208-541-4584

**NIKON CEE GMBH**

AUSTRIA phone: +43-1-972-6111 fax: +43-1-972-611-140

**NIKON SINGAPORE PTE LTD**

SINGAPORE phone: +65-6559-3651 fax: +65-6559-3668

**NIKON INSTRUMENTS KOREA CO., LTD.**

KOREA phone: +82-2-2186-8400 fax: +82-2-555-4415

