



Motic®

MORE THAN MICROSCOPY

SMZ171 | **FLEXIBLE
STEREOMICROSCOPE
SOLUTION**

SMZ171

With the **new SMZ-171 Stereo Zoom microscope** Motic proudly introduces an optically improved addition to its well-established SMZ Stereo series. New materials for ESD compatibility as well as optimized LED illumination options have been added to this series to create a versatile Stereo microscope platform for a wide range of **biological and material science applications**. The SMZ-171's optical performance, combined with its expanded accessory line, make it an ideal instrument for the demanding requirements **for both routine and research fields**. From biological and medical preparations to industrial quality control and inspection, the SMZ-171 will deliver repeatedly clear and distortion-free images.

The **Greenough optical system** comes with a large-scale **zoom range of 6.7:1, parfocal at all magnifications**; while a **5-position click-stop mechanism**, implemented in the continuous zoom, enables **precise reproduction of magnifications** for easy measurements. The **working distance of 110mm** in its standard configuration gives sufficient space for any kind of sample viewing and manipulation. Also, an enhanced and crisp depth-of-view produces consistent and convincing 3-dimensional upright images. Further, the SMZ-171 can convert easily into a complete documentation station by combining it with a member of the Moticam camera family.



FLEXIBLE STEREOMICROSCOPE SOLUTION



Zoom Range

Switching from a macro overview down to micro details has never been easier than with the SMZ-171. **One rotation of the zoom knob** gives access to the **complete magnification range**. Five defined **click-stop positions within the continuous zoom** allow exact reproduction of magnifications, a necessary precondition for **precise measurements** by reticules or digital imaging tools.

The **6.7:1 zoom ratio** in the SMZ-171 enables a **standard magnification range of 7.5X-50X**. While zooming, a re-adjustment of the focus position is not necessary—as the complete optical system is designed for **parfocality through the complete zoom range**. **To increase the model's magnification range** a selection of **auxiliary objectives and eyepieces** are also available, extending the SMZ-171's total magnification range from 2.25X up to 200X.

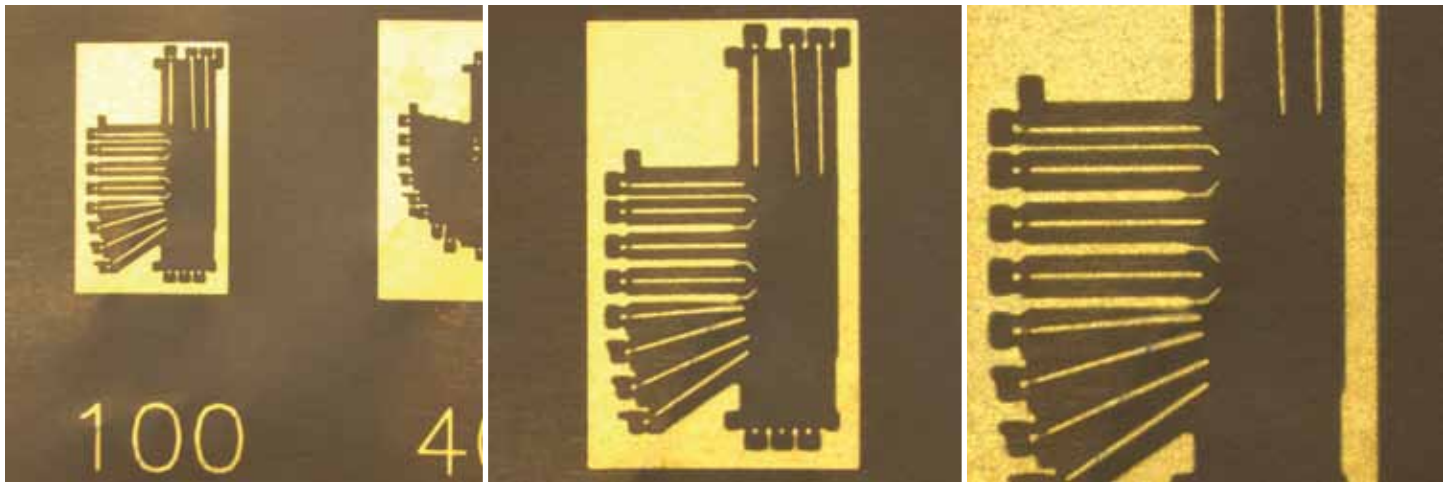

Auxiliary ESD Objectives

With a standard **working distance of 110mm**, the SMZ-171 offers sufficient space for sample manipulation through various magnifications. The maximum field diameter (with lowest zoom position and 10X eyepieces) will be 30.7mm. Higher magnifications can be achieved by using the following auxiliary objectives, **which follow ESD requirements**:

Magnification	W.D.(mm)	Max. Field Diameter (with 10X eyepiece)
1.5X	56.3	20.4
2X	38.6	15.3

To achieve a larger sample overview, the following auxiliary objectives may be chosen:

Magnification	W.D.(mm)	Max. Field Diameter (with 10X eyepiece)
0.3X	301	102.2
0.5X	191.8	61.3
0.63X	142.7	48.7
0.75X	128.6	40.9





Eyepieces

The SMZ-171's **standard Widefield 10X/23mm** eyepieces follow the **high eyepoint principle**, giving spectacle wearers access to the complete field of view. Individual eyepiece **diopter adjustments of +/- 5 dpt** provide the best conditions for the use of reticules, while standard rubber eye guards minimize stray light and increase viewing comfort. Beside the standard 10X eyepiece magnification, the SMZ-171 Series also offers eyepieces with **alternative magnifications**:

Description	F.N.
N-WF 12.5X	18
N-WF 15X	16
N-WF 20X	13

For measuring purposes, a series of reticules are available:

- Bidirectional scale 10mm:100 and crosshair
- Bidirectional scale 10mm:100
- Micrometer (100 divisions in 10mm) (25mm diameter) with crosshair
- Micrometer (100 divisions in 10mm) (25mm diameter)
- Scale 360°: 360 and crosshair
- Scale 360°: 36 and crosshair
- Simple crosshair

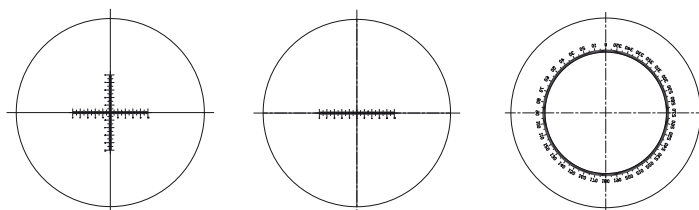



3-D Image

Stereo microscopes have found a large variety of application fields in life sciences, industry, as well as in areas of botany or mineralogy. The upright image of a stereo microscope is essential for manipulation work. While there is no need for sample preparation, stereo microscopes are ideal instruments for first steps into the “micro world”.

Motic's SMZ-171 is based on the Greenough Optical System. With its completely separated optical paths, this system has been a proven concept for more than 100 years of microscopy. The SMZ-171 delivers **impressive 3-D images, distortion-free**, and with a high **resolving power of maximum 460 lp/mm** (with 2X auxiliary objective).

The Working Distance

Sample manipulation is a major activity when using a stereo microscope. The upright image orientation, typical for a stereo microscope, is essential when using tweezers, needles or similar dissection tools.

With its standard configuration, the SMZ-171 provides a large **working distance of 110 mm**, which can be easily **extended to 301mm** (with additional auxiliary objective 0.3X). To achieve a desired total magnification, objective magnifications less than 1X may be compensated by using high magnification eyepieces (up to 20X).



Standard Packages

The optical heads of Motic's SMZ-171 come as **Binocular** or **Trinocular** versions with **45° viewing angle**, 10X eyepieces and a built-in 1X objective. The interlock eyepieces can be adjusted with an interpupillary distance from 48mm to 75mm. For special setups or OEM applications, a **Binocular head with 60° viewing angle** is available. The **anti-fungus treatment** of all optics allows the use of the SMZ-171 in humid environments.



ESD arm stand

SMZ-171 Base Stands

Beside the variability in optical setup (auxiliary objectives, eyepieces), Motic offers a wide range of stands to be used with the SMZ-171. Both the **classic pole stands** (pole diameter 32mm) as well as the new arm stand are available **also in an ESD version** for electrostatic sensitive industries.

The optional integrated illumination for incident and transmitted light is based on 3W LED light sources. Both LED illuminations can be activated simultaneously and adjusted separately. Designed with fiber-optic interface at the back of the Transmitted light base, the Motic cold light MLC-150 can be adapted additionally by a flexible light guide. By pulling a lever, a switch between both illuminations can be achieved. With a built-in reflector device, for Transmitted light the angle of illumination can be easily modified to meet the demand for oblique illumination.

The standard packages



Description	SMZ-171-BP	SMZ-171-TP	SMZ-171-BLED	SMZ-171-TLED
SMZ-171 Binocular Head 45°	●		●	
SMZ-171 Binocular Head 60°	●		●	
SMZ-171 Trinocular Head 45°		●		●
Widefield 10X/23 eyepieces	●	●	●	●
Standard Stand - Pole version - Plain Stand	●	●		
Standard Stand - Pole version - Holder	●	●		
Standard Stand - Pole stand			●	●
Standard Stand - Arm Stand			●	●
ESD Stand - Pole version - Plain Stand	●	●		
ESD Stand - Pole version - Holder	●	●		
ESD Stand - Pole Stand			●	●
ESD Stand - Arm Stand			●	●
Incident Light - 3W LED			●	●
Transmitted Light - 3W LED			●	●

● included ● available as optional

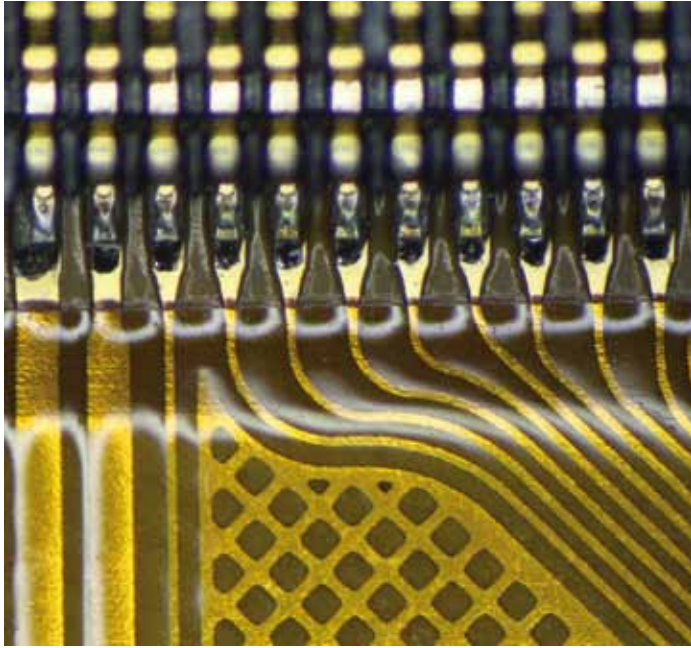

Modular Configuration

Besides the Base stands, the SMZ-171 also offers a **modular component system** for personal preferences and requirements regarding the workplace setup.

The industrial boom stands for larger viewing samples may replace the Base Plain and transmitted light stands to significantly **increase user freedom**. A new slot-and-groove design improves the stability of the desired optics position without slant. For better transport, all round, rectangular bases bare an “easy hand-carrying shape”. All these stands require a separate illumination system following the requirements of the sample.

1. Special Universal stand (round base)

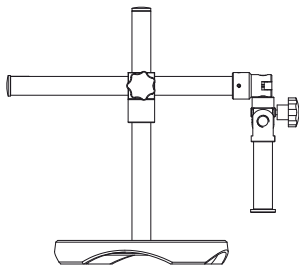

Base: Ø300mm, 40mm thick
 Vertical pole: Ø32mm
 Height of vertical pole: 400mm (optional: 600mm)
 Focusing pole: Ø32mm
 Max. distance from pole to optical centre: 566mm

2. Special Universal stand (squared base)

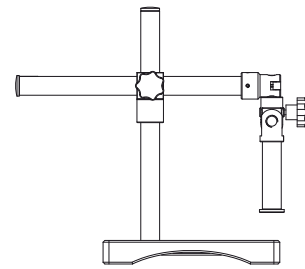

Base: 300x300x40 mm
 Vertical pole: Ø32mm
 Height of vertical pole: 400mm (optional: 600mm)
 Focusing pole: Ø32mm
 Max. distance from pole to optical centre: 566mm

3. Industrial arm boom stand

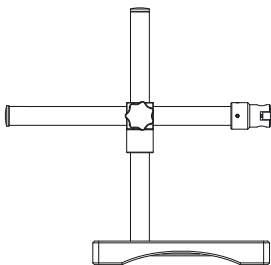

Base: 300x300x40 mm
 Vertical pole: Ø32mm
 Height of vertical pole: 400mm (optional: 600mm)
 Industrial arm: Ø16mm
 Max. distance from pole to optical centre: 566mm
 Connected with the industrial arm directly without focusing connector

4. Articulating boom stand (clamp version)

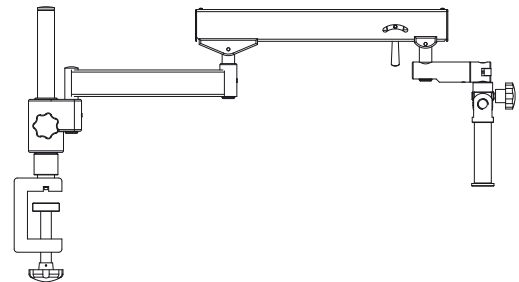

Vertical pole: Ø32mm
 Height of vertical pole: 400mm (optional: 600mm)
 Focusing pole: Ø32mm
 Maximum thickness of table: 75mm
 Max. distance from pole to optical centre: 985mm



5. Articulating boom stand

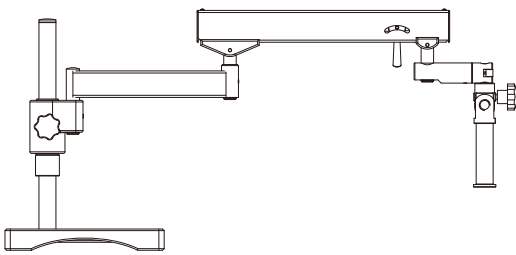

Base: 300x300x40 mm
 Vertical pole: Ø32mm
 Height of vertical pole: 400mm (optional: 600mm)
 Focusing pole: Ø32mm
 Max. distance from pole to optical centre: 985mm

6. Ball bearing boom stand (clamp version)

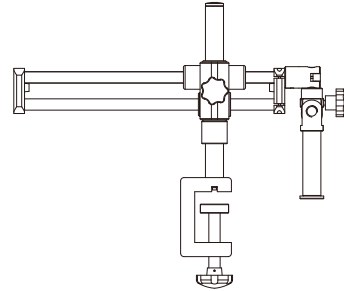

Vertical pole: Ø32mm
 Height of vertical pole: 400mm (optional: 600mm)
 Focusing pole: Ø32mm
 Maximum thickness table: 75mm
 Max. distance from pole to optical centre: 605mm

7. Ball bearing boom stand

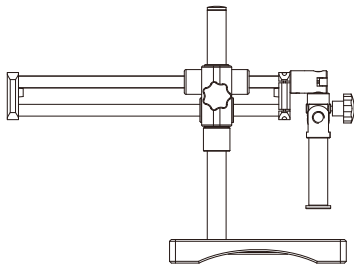

Base: 300x300x40 mm
 Vertical pole: Ø32mm
 Height of vertical pole: 400mm (optional: 600mm)
 Focusing pole: Ø32mm
 Max. distance from pole to optical centre: 605mm

8. Manual movement stand

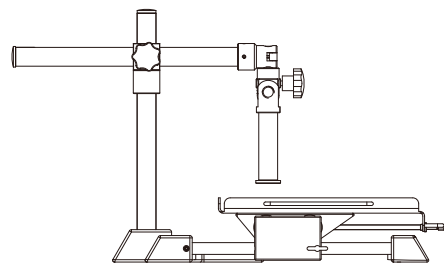

Surface perimeter: 450mm x 350mm
 X movement: 410mm
 Y movement: 220mm
 Vertical pole: Ø32mm
 Height of vertical pole: 400mm (optional: 600mm)
 Focusing pole: Ø32mm



Illumination

Illumination is an integral part in the proper use of a stereo microscope. To receive all possible detail information from a sample, carefully thought about illumination options need to be executed. Motic offers a wide range of illumination options to be combined with the SMZ171 optics.

The **built-in LED base-stand illumination option** provides the **most compact** and easy-to-use illumination configuration. Especially when viewing live biological samples, Motic's choice for **LED** illumination is most-desired due to its reduced, non-existent heat development, resulting in minimal impact on living specimen.

However, for more demanding applications, a more powerful or variable solution may be necessary. A **ring light** might be required for a **shadow-free image**, while the visualization of a surface structure may need a unidirectional illuminator by combining a cold light source with a light guide.

Optional ring lights are:

2401K Fluorescent ring illumination
220V/12W - 6400K color temperature (CE)

LED ring illumination 60T-B dimmable
+/- 6800K color temperature (CE)

LED ring illumination 60T dimmable and segmentable
+/- 6500K color temperature (CE)



A **more powerful solution** is provided by the Motic **Cold light source MLC-150**. A variety of light guides for flexible illumination options are also available.

MLC-150 Fiber optic illuminator

- 21V/150W Halogen Illumination
- Switching power supply 100-240V (CE)
- Local/remote switch for intensity control
- Color temperature LED read out



Flexible PVC sheathing light guide
1.5m length with standard straight distal end type



Ring light guide Ø 61mm
1m length with Ø 61mm distal end



Gooseneck 1-Arm light guide
0.5m length with standard straight distal end type



Gooseneck 2-Arm light guide
0.5m length with standard straight distal end type

Accessories

Especially when working with higher magnifications, **handling samples** becomes more sensitive to vibrations. For this reason, an appropriate solution to build a model to enhance viewing comfort may be found within the SMZ71's optional stage accessories.

Gliding stage

For smooth multidirectional movement of the sample, a 360° rotatable gliding stage can be mounted onto the base plate of a Plain or Transmitted light stand.

x/y-stage with rotatable insert

An attachable x/y-stage with 76X54mm travel range enables a precise bidirectional movement. A rotatable insert is available as an option.

Polarizer, Analyzer

To analyze the birefringence of transparent materials, a polarizing set-up is required. The respective polarizer for the SMZ171 is fixed on top of the light exit of the transmitted light stand, while the analyzer is clamped on the objective. Both polarizer and analyzer are 360° rotatable.

Darkfield insert

For Darkfield applications, a special DF insert is mounted on top of the light exit of the Transmitted light stand. The iris diaphragm allows variation of the illumination aperture according to the numerical aperture of the objective in use.



Standard Photomicrography

The adaption of a traditional single lens reflex camera (SLR), today mostly digital, requires a Trinocular version of the SMZ171. The camera **adapter** consists of a **mechanical part, to be combined with a 2.5X or 4X photo eyepiece**. The necessary **T2 adapter** which connects to the camera's bayonet mount-type is supplied by the respective camera manufacturer. This setup delivers **high resolution images of small fields**.

Digital Documentation

A more convenient setup is provided through **Motic's philosophy of easy image digitalization**. The combination of a SMZ171 with a member of the Moticom Series of digital cameras delivers **excellent live images**, which can easily be stored for future usage. **All Motic cameras come equipped with software** to transform the SMZ171 into an analysis and documentation workstation. For the Binocular SMZ171, multiple eyepiece adapters for Motic cameras are available. The Trinocular SMZ171 allows the use of **different camera adapters**, depending on the chip size of the camera in use. Motic offers a **complete range of digital cameras**, starting with a basic resolution of 1.3MP (CMOS) up to the research grade Moticom Pro Line (CCD) with a range of 1 megapixel and beyond, including Monochrome and Cooled versions where necessary. These Moticom cameras deliver sharp live images with an all-inclusive software package for easy post-capture handling, measurement and annotation. For further details on our range of cameras, as well as on adaptation questions, please contact your nearest Motic office or your local authorized Motic Professional reseller.



SMZ-171 General Specifications

Model	SMZ-171 BL	SMZ-171 TL
Optical system	Greenough	
Observation angle	45°/60°	45°
Magnification range (standard)	0.75X - 5X	
Zoom ratio	1:6.7	
Eyepiece	N-WF high eyepoint 10X (Ø23) / Diopter adjustable - Optional: N-WF 12.5X (Ø18), 15X (Ø16), 20X (Ø13)	
Interpupillary adjustment	48mm-75mm	
Height of eye point	405mm	
Working distance	110mm	
Max. working distance	301mm	
Weight	6.2Kg (head 1.4Kg)	
C-Mount adapter	-	Trinocular head only
	-	0.5X, 0.65X, 1X adapters available
Photo adapter	-	Photo adapter, 2.5X, 4x photo eyepiece available
Auxiliary ESD objectives	0.3X (WD = 301 mm) - 0.5X (WD = 191.8 mm) - 0.63X (WD = 142.7 mm) 0.75X (WD = 128.6 mm) - 1.5X (WD = 56.3 mm) - 2.0X (WD = 38.6 mm)	
Stand option	See system diagram	

SMZ-171 Optical Data

Eyepiece	Magnification (X)	Standard Objectives		Auxiliary Objectives											
				0.3X		0.5X		0.63X		0.75X		1.5X		2X	
		WD 110mm	WD 301 mm	WD 191.8 mm	WD 142.7 mm	WD 128.6 mm	WD 56.3 mm	WD 38.6 mm	Mag.(X)	F.N.(mm)	Mag.(X)	F.N.(mm)	Mag.(X)	F.N.(mm)	Mag.(X)
10X/23 high eyepoint eyepiece	0.75	7.50	30.67	2.25	102.22	3.75	61.33	4.73	48.68	5.63	40.89	11.25	20.44	15.00	15.33
	1	10.00	23.00	3.00	76.67	5.00	46.00	6.30	36.51	7.50	30.67	15.00	15.33	20.00	11.50
	2	20.00	11.50	6.00	38.33	10.00	23.00	12.60	18.25	15.00	15.33	30.00	7.67	40.00	5.75
	3	30.00	7.67	9.00	25.56	15.00	15.33	18.90	12.17	22.50	10.22	45.00	5.11	60.00	3.83
	4	40.00	5.75	12.00	19.17	20.00	11.50	25.20	9.13	30.00	7.67	60.00	3.83	80.00	2.88
	5	50.00	4.60	15.00	15.33	25.00	9.20	31.50	7.30	37.50	6.13	75.00	3.07	100.00	2.30
12.5X/18	0.75	9.38	24.00	2.81	80.00	4.69	48.00	5.91	38.10	7.03	32.00	14.06	16.00	18.75	12.00
	1	12.50	18.00	3.75	60.00	6.25	36.00	7.88	28.57	9.38	24.00	18.75	12.00	25.00	9.00
	2	25.00	9.00	7.50	30.00	12.50	18.00	15.75	14.29	18.75	12.00	37.50	6.00	50.00	4.50
	3	37.50	6.00	11.25	20.00	18.75	12.00	23.63	9.52	28.13	8.00	56.25	4.00	75.00	3.00
	4	50.00	4.50	15.00	15.00	25.00	9.00	31.50	7.14	37.50	6.00	75.00	3.00	100.00	2.25
	5	62.50	3.60	18.75	12.00	31.25	7.20	39.38	5.71	46.88	4.80	93.75	2.40	125.00	1.80
15X/16 high eyepoint eyepiece	0.75	11.25	21.33	3.38	71.11	5.63	42.67	7.09	33.86	8.44	28.44	16.88	14.22	22.50	10.67
	1	15.00	16.00	4.50	53.33	7.50	32.00	9.45	25.40	11.25	21.33	22.50	10.67	30.00	8.00
	2	30.00	8.00	9.00	26.67	15.00	16.00	18.90	12.70	22.50	10.67	45.00	5.33	60.00	4.00
	3	45.00	5.33	13.50	17.78	22.50	10.67	28.35	8.47	33.75	7.11	67.50	3.56	90.00	2.67
	4	60.00	4.00	18.00	13.33	30.00	8.00	37.80	6.35	45.00	5.33	90.00	2.67	120.00	2.00
	5	75.00	3.20	22.50	10.67	37.50	6.40	47.25	5.08	56.25	4.27	112.50	2.13	150.00	1.60
20X/13	0.75	15.00	17.33	4.50	57.78	7.50	34.67	9.45	27.51	11.25	23.11	22.50	11.56	30.00	8.67
	1	20.00	13.00	6.00	43.33	10.00	26.00	12.60	20.63	15.00	17.33	30.00	8.67	40.00	6.50
	2	40.00	6.50	12.00	21.67	20.00	13.00	25.20	10.32	30.00	8.67	60.00	4.33	80.00	3.25
	3	60.00	4.33	18.00	14.44	30.00	8.67	37.80	6.88	45.00	5.78	90.00	2.89	120.00	2.17
	4	80.00	3.25	24.00	10.83	40.00	6.50	50.40	5.16	60.00	4.33	120.00	2.17	160.00	1.63
	5	100.00	2.60	30.00	8.67	50.00	5.20	63.00	4.13	75.00	3.47	150.00	1.73	200.00	1.30

SMZ-171 Schematic Diagrams

SMZ-171-BP

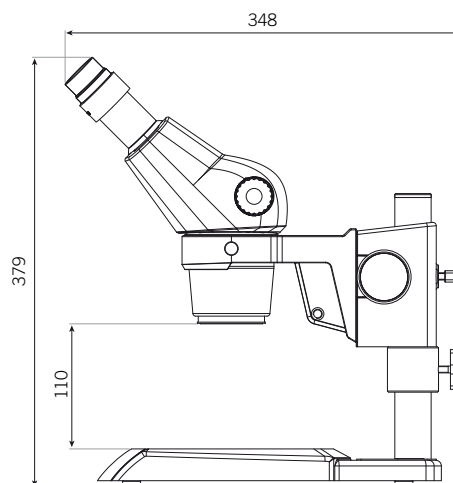
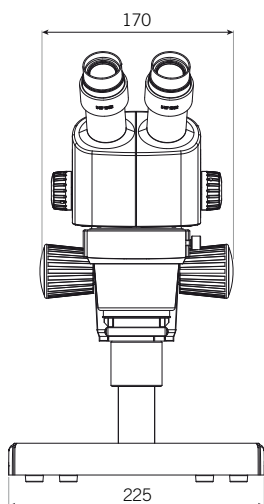

SMZ-171-BL

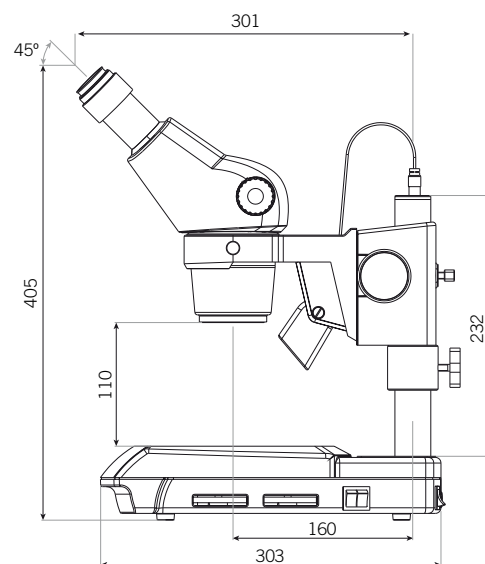
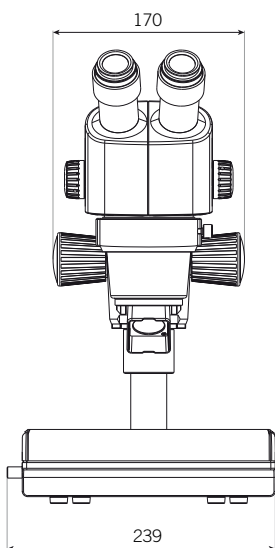

SMZ-171-BL (60°)

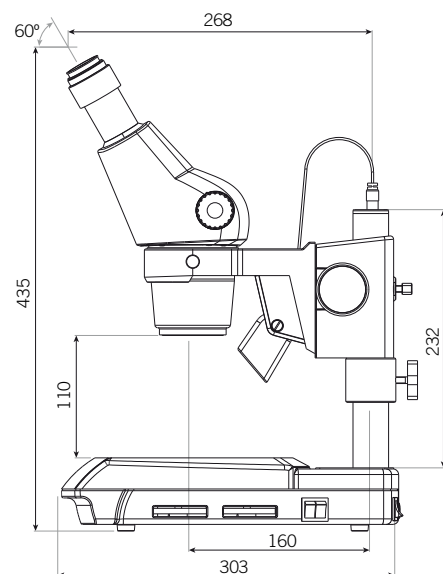
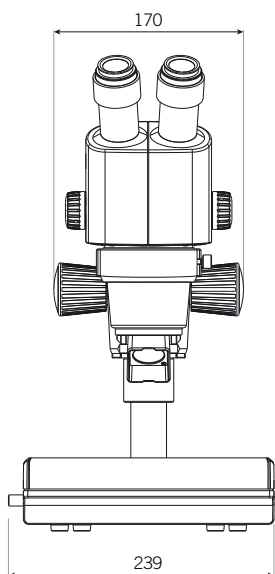

SMZ-171 System Diagram

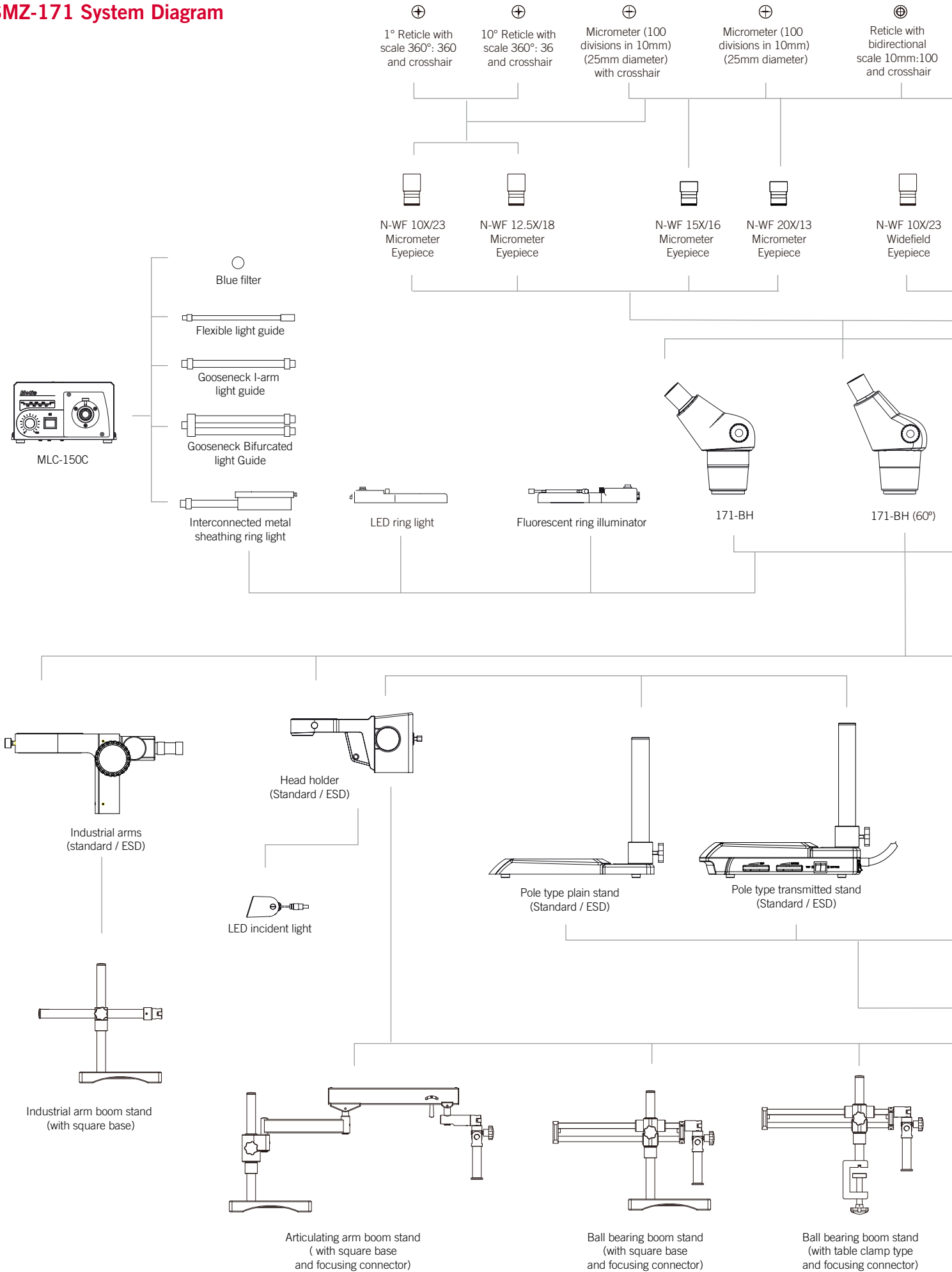

⊕
Reticle with
bidirectional
scale 10mm:100

⊕
Crosshair
Reticle



N-WF 12.5X/18
Widefield
Eyepiece



N-WF 15X/16
Widefield
Eyepiece



N-WF 20X/13
Widefield
Eyepiece



2.5X
Photo eyepiece



4X
Photo eyepiece



1X Adapter



0.65X Adapter



0.5X Adapter



Photo adapter

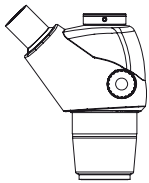

171-TH



2X
Auxiliary objective



1.5X
Auxiliary objective



0.75X
Auxiliary objective



0.63X
Auxiliary objective



0.5X
Auxiliary objective



0.3X
Auxiliary objective

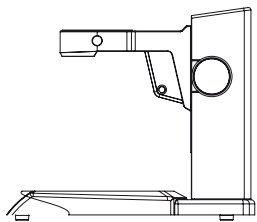

Fixed arm plain stand
(Standard / ESD)

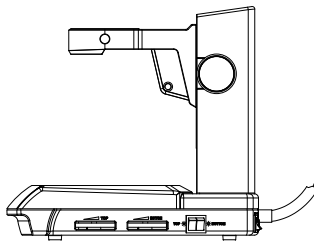

Fixed arm transmitted stand
(Standard / ESD)



Jewellery
clip



Polarising
equipment

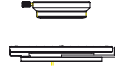

Polarising
kit



Darkfield
attachment

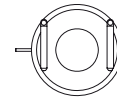

Gliding
stage

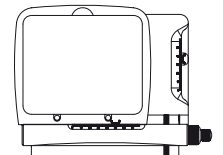

Mechanical
stage

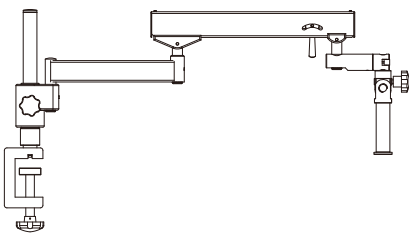

Articulating arm boom stand
(with table clamp type
and focusing connector)

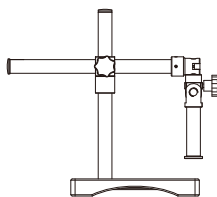

Special universal stand
(with square base
and focusing connector)

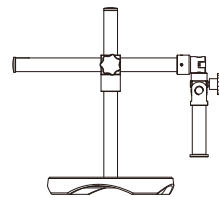

Special universal stand
(with round base
and focusing connector)

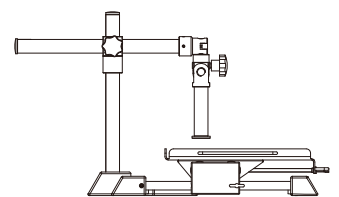

Manual movement stand



Motic®

www.moticeurope.com

Motic Instruments (CANADA)

130 - 4611 Viking Way. Richmond, BC V6V 2K9 Canada
Tel: 1-877-977 4717 Fax: 1-604-303 9043

Motic Deutschland GmbH (GERMANY)

Christian-Kremp-Strasse 11, D-35578 Wetzlar, Germany
Tel: 49-6441-210 010 Fax: 49-6441-210 0122

Motic Incorporation Ltd. (HONG KONG)

Rm 2907-8, Windsor House, 311 Gloucester Road,
Causeway Bay, Hong Kong
Tel: 852-2837 0888 Fax: 852-2882 2792

Motic Spain, S.L. (SPAIN)

Polígono Industrial Les Corts, Camí del Mig, 112
08349 Cabrera de Mar, Barcelona, Spain
Tel: 34-93-756 6286 Fax: 34-93-756 6287

* **CCIS®** is a trademark of Motic Incorporation Ltd.

**Motic Incorporation Limited Copyright © 2002-2013.
All Rights Reserved.**

Design Change :

The manufacturer reserves the right to make changes in instrument design in accordance with scientific and mechanical progress, without notice and without obligation.



January 2013

