

# INSTRUCTIONS

---

# CX43-RFAB

## B excitation fluorescence illuminator

To ensure the safety, obtain optimum performance and to familiarize yourself fully with the use of this product, we recommend that you study this manual thoroughly before operating this product, and always keep this manual reachable when operating this product.

Optical Microscope Accessory

This product is applied with the requirements of standard IEC/EN61326-1 concerning electromagnetic compatibility.

- Immunity Applied to industrial and basic environment requirements.



In accordance with European Directive on Waste Electrical and Electronic Equipment, this symbol indicates that the product must not be disposed of as unsorted municipal waste, but should be collected separately.

Refer to your local distributor in EU for return and/or collection systems available in your country.

**NOTE:** This product has been tested and found to comply with the limits for a Class A digital device, pursuant to Part 15 of the FCC Rules. These limits are designed to provide reasonable protection against harmful interference when the product is operated in a commercial environment. This product generates, uses, and can radiate radio frequency energy and, if not installed and used in accordance with the instruction manual, may cause harmful interference to radio communications.

Operation of this product in a residential area is likely to cause harmful interference in which case the user will be required to correct the interference at his own expense.

**FCC WARNING:** Changes or modifications not expressly approved by the party responsible for compliance could void the user's authority to operate the product.

**For Korea only**

이 기기는 업무용 환경에서 사용할 목적으로 적합성 평가를 받은 기기로서 가정용 환경에서 사용하는 경우 전파간섭의 우려가 있습니다.

# Contents

<b>Introduction .....</b>	<b>1</b>
<b>Safety precautions.....</b>	<b>2</b>
<b>1 Nomenclature of microscope operating portions.....</b>	<b>6</b>
<b>2 Reflected fluorescence observation method .....</b>	<b>7</b>
<b>3 Operation procedures .....</b>	<b>8</b>
<b>1</b> Operating the B excitation fluorescence illuminator .....	8
<b>2</b> Escaping the condenser top lens .....	9
<b>4 Assembly.....</b>	<b>10</b>
<b>1</b> Attaching the B excitation fluorescence illuminator.....	10
<b>2</b> Connecting the AC adapter and power cord.....	11
<b>3</b> Attaching the hook stick holder .....	12
<b>5 Specifications.....</b>	<b>13</b>





# Introduction

This product is used for a reflected light fluorescence observation in combination with the biological microscope CX43.

If the product is used in a manner not specified by this manual, the safety of the user may be imperiled. In addition, the product may also be damaged. Always use the product according to this instruction manual.

The following symbols are used in this instruction manual.

 **CAUTION** : Indicates a potentially hazardous situation which, if not avoided, may result in minor or moderate injury.

 **NOTE** : Indicates a potentially hazardous situation which, if not avoided, may result in damage to the product or other property.

 **TIP** : Indicates the useful knowledge or information for use.

# Safety precautions

## CAUTION - Electric safety -

### **Always use the AC adapter and power cord provided by us.**

If the proper AC adapter and the power cord are not used, the electric safety and the EMC (Electro-Magnetic Compatibility) performance of the product cannot be assured. If no power cord is provided, please select the proper power cord by referring to the section "Proper selection of the power cord" at the end of this instruction manual.

### **Always connect the ground terminal.**

Check that the ground terminal of the power cord and that of the power outlet are connected properly. If the product is not grounded, our intended electric safety and EMC performance of the product cannot be assured.

### **Do not use this product near the sources of strong electromagnetic radiation.**

Proper operation may be interfered. Be sure to evaluate the electromagnetic environment before operating the product.

### **Disconnect the power cord in case of emergency.**

In case of emergency, disconnect the power cord from the power cord connector of the product or from the power outlet.

Install the product at the location where you can reach the power cord connector or the power outlet with your hand to disconnect the power cord immediately.

This product complies with the emission and immunity requirements described in IEC61326 series.

 **CAUTION - LED (light emitting diode) -****Do not look directly at the light from LED for a long time.**

If you feel that the light from LED is too bright during observation, adjust the light intensity using the brightness adjustment knob before continuing the observation. The LED built in this product is basically eye-safe. However, do not look directly at the light from LED for a long time while feeling too bright, since it may cause damage to your eyes.

This product is categorized as Risk Group 2 defined in IEC/EN 62471 "Photobiological Safety of Lamps and Lamp Systems".

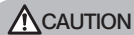
**CAUTION**

**Possibly hazardous optical radiation emitted from this product.  
Do not stare at operating lamp. May be harmful to the eyes.**



 **CAUTION - Light from the objective -****Do not look directly at the light coming out from the objective or the light reflected from the specimen.**

Be careful about the light coming out from the objective, since not only visible light but also light of invisible wavelengths (such as ultraviolet and infrared) may be emitted depending on the illumination methods.

## CAUTION - Safety symbols -

The following symbols are attached to the product.

Study the meaning of the symbols and always use the product in the safest possible manner.

Symbol	Meaning
	Indicates a non-specific general hazard. Follow the description given after this symbol or in the instruction manual.
	Indicates that the main switch is ON.
	Indicates that the main switch is OFF.

## Handling precautions

**NOTE**

- This product is a precision instrument. Handle it with care and avoid subjecting it to a sudden or severe impact.
- Never disassemble any part of the product. Otherwise, failure could be caused.
- Do not carry the microscope keeping the AC adapter connected to the microscope. The AC adapter or the microscope may be damaged by hitting the output connector of the AC adapter.



## Maintenance and storage

1. Do not leave stains or fingerprints on the lenses and filters. If they get dirty, blow away dust with a commercially available blower and gently wipe the lens or filter with a piece of cleaning paper (or clean gauze). Only when cleaning fingerprints and oil stains, slightly moisten a piece of cleaning paper with commercially available absolute alcohol and wipe them off with it.

 **CAUTION**

**Since the absolute alcohol is highly flammable, it must be handled carefully. Be sure to keep it away from open flames or potential sources of electrical sparks. For example, the electrical equipment that is switched ON and OFF may cause the ignition of a fire. Also, always use absolute alcohol only in a well-ventilated room.**

2. Wipe the portions other than the lens with a dry soft cloth. If the dirt cannot be removed by dry-wiping, moisten a soft cloth with diluted neutral detergent and wipe the dirty surface with it.

**NOTE**

**Do not use organic solvents because they may deteriorate the coated surface or plastic parts.**

3. When disposing of this product, be sure to follow the regulations and rules of your local government. Contact us for any questions.

# 1

## Nomenclature of microscope operating portions

The number indicating the operation portion corresponds to the observation method described on the next page.

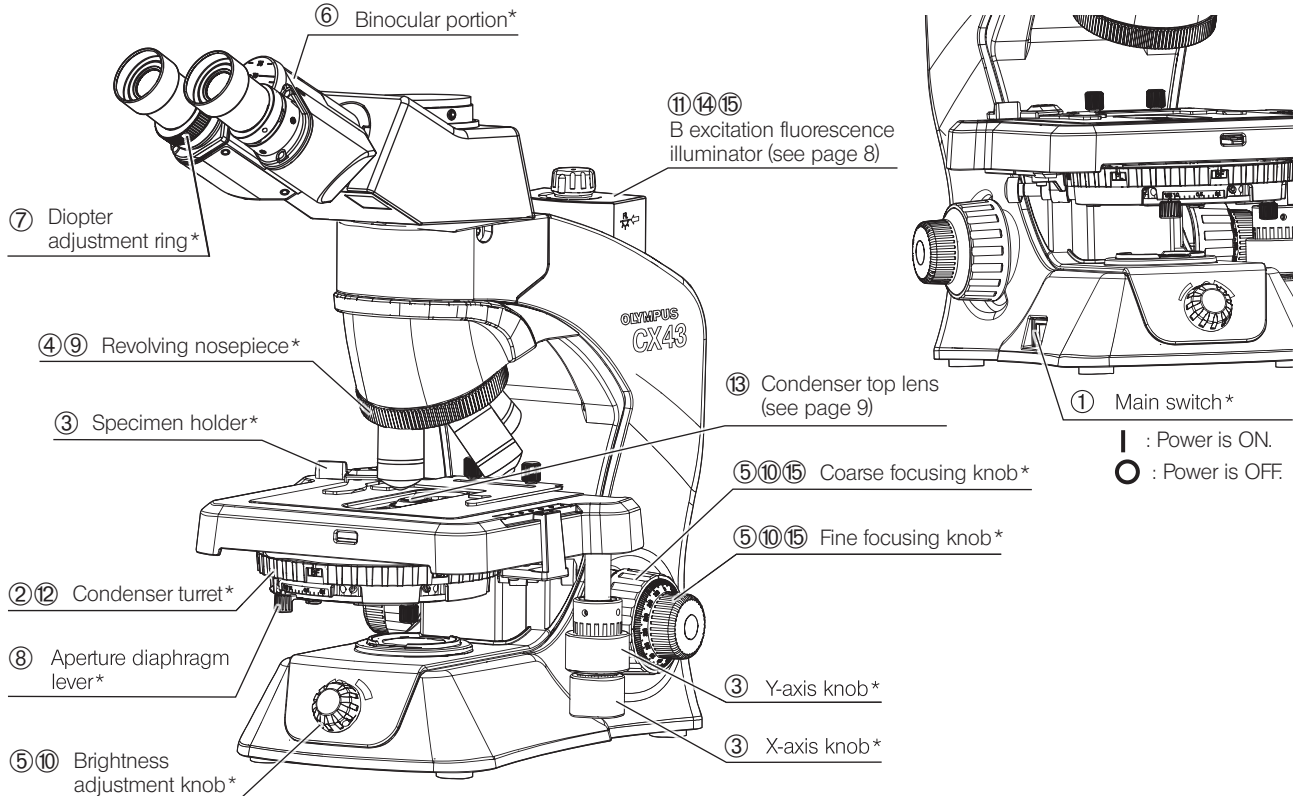

6

\* : For operating procedures, refer to the instruction manual of the microscope frame (CX43).

# 2 Reflected fluorescence observation method

For reflected fluorescence observation, the B excitation fluorescence illuminator is necessary.

(For attaching procedures, see “4 Assembly” on page 10.)

If the analyzer for simple polarization and the polarizer are engaged in the light path, remove them from the light path.

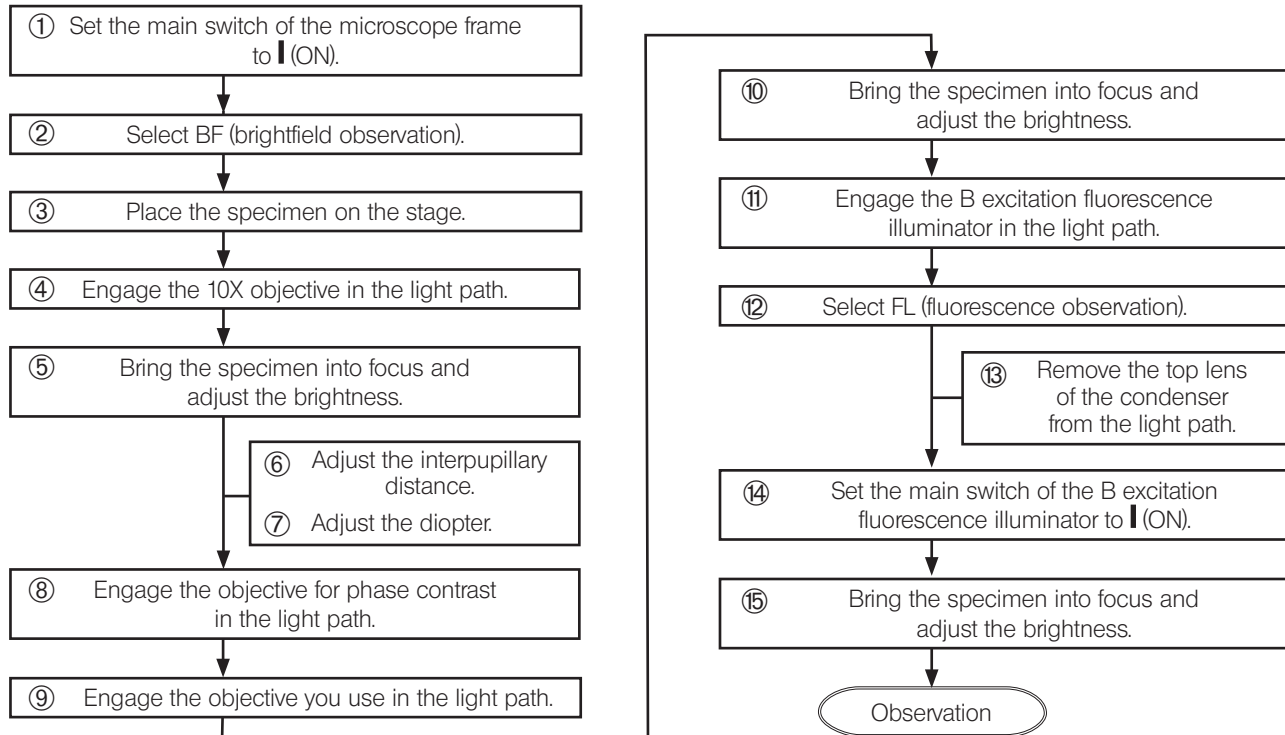

# 3 Operation procedures

## 1 Operating the B excitation fluorescence illuminator

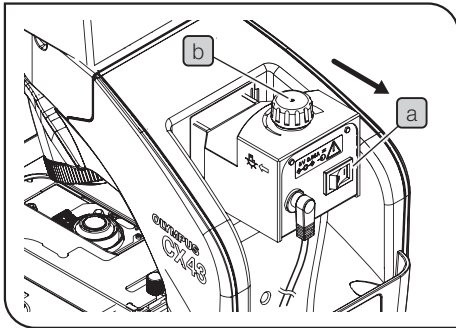

TIP

For attaching and removing the B excitation fluorescence illuminator, see page 10.

1

Set the main switch **a** of the B excitation fluorescence illuminator to **I** (ON).

TIP

When the B excitation fluorescence illuminator is not in use, slide it in the arrow direction until it touches the end to remove it from the light path.

NOTE

- When attaching various intermediate attachments, if the brightness adjustment knob of the B excitation fluorescence illuminator is interfered or cannot be operated, the intermediate attachment must be attached again by changing its angle.
- When carrying the microscope, be sure to remove the B excitation fluorescence illuminator in advance, since it may be in danger of dropping.

### Adjusting the brightness

1

Rotate the brightness adjustment knob **b** to adjust the brightness.

## 2 Escaping the condenser top lens

TIP

During fluorescence observation, when the background light of the field of view becomes darker, the contrast of the fluorescence observation image is improved. If the condenser turret is set to FL (fluorescence observation), the background light of the field of view can be darker than that of other turret positions. If you want to make the background light of the field of view darker effectively, escape the condenser top lens from the light path.

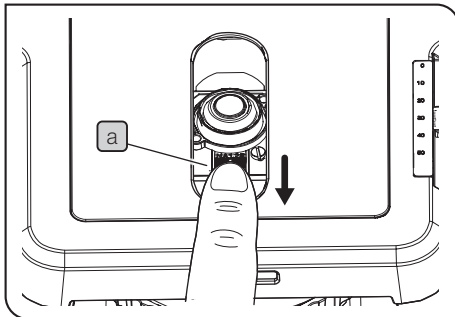

### Using the finger

- 1 Insert the finger to the aperture of the stage, press the finger hook portion **a** and move the top lens to the front (arrow direction).

### Using the hook stick

TIP

If the finger cannot be inserted to the aperture of the stage due to using the specimen holder for observing two slide glasses or plain specimen holder, use the hook stick provided with the B excitation fluorescence illuminator.

- 1 Insert the hook stick **b** in the insertion hole on the front of the stage, hook it over the pin **c** near the top lens and move the top lens to the front (arrow direction).

NOTE

**Be sure to store the hook stick in a safe place.**

TIP

When using the plain specimen holder, it is recommended to remove the top lens from the light path in advance prior to observation.

# 4 Assembly

## 1 Attaching the B excitation fluorescence illuminator

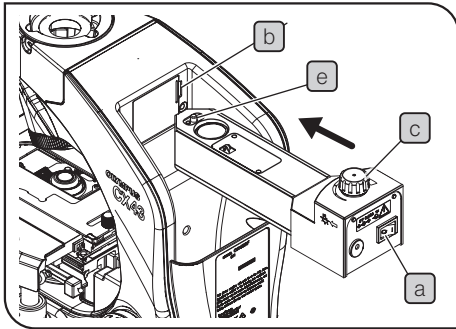

**CAUTION**

Be sure to set the main switch **a** of the B excitation fluorescence illuminator to **○** (OFF) before attaching or removing the B excitation fluorescence illuminator.

- 1 Remove the cover plate for insertion portion of the fluorescence illuminator by inserting the flathead screwdriver into the notch **b**.

**NOTE**

Be sure to store the cover plate in a safe place.

- 2 Insert the B excitation fluorescence illuminator into the insertion portion of the fluorescence illuminator with the brightness adjustment knob **c** facing up, and push it completely until it touches the end.

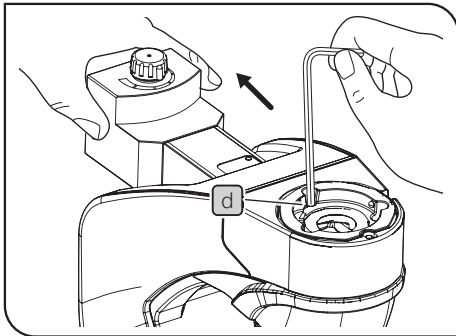

### Removing the B excitation fluorescence illuminator

- 1 Insert the allen wrench provided with the microscope frame into the hole **d** at the tube attaching portion of the microscope frame, and push the stopper **e** attached to the B excitation fluorescence illuminator to pull out the B excitation fluorescence illuminator.

**NOTE**

When removing the B excitation fluorescence illuminator, attach the cover plate to prevent dust.

## 2 Connecting the AC adapter and power cord

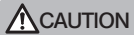

Always use the AC adapter and power cord provided by us. If the proper AC adapter and the power cord are not used, the electric safety and the EMC (Electro-Magnetic Compatibility) performance of the product cannot be assured. If no power cord is provided, please select the proper power cord by referring to the section “Proper selection of the power cord” at the end of this instruction manual.

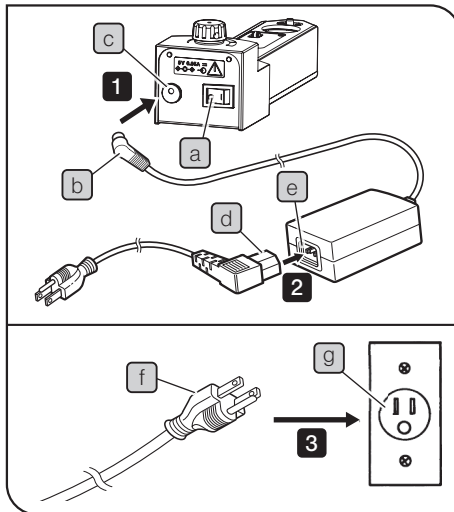

### NOTE

- The power cord and AC adapter cord are vulnerable when bent or twisted. Never subject them to excessive force.
- Be sure to set the main switch of the B excitation fluorescence illuminator **a** to **○** (OFF) before connecting the AC adapter and the power cord.

- 1 Connect the output connector **b** of the AC adapter to the input connector **c** on the rear of the microscope.
- 2 Connect the connector portion **d** of the power cord to the connector **e** completely.
- 3 Connect the power cord's plug **f** to the power outlet **g** on the wall.

### 3 Attaching the hook stick holder

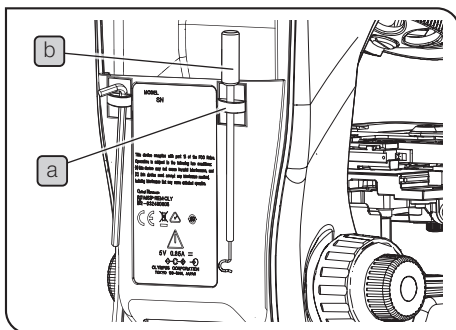

#### TIP

- It is recommended to attach the provided hook stick holder (a) to the back of the microscope frame.
- The provided hook stick (b) can be fixed to the provided hook stick holder (a).



# 5 Specifications

Item	Specification
Light source	Blue LED (470nm)
Rating	Body portion (rated input power): 5 V 0.85 A $\overline{\text{---}}$ AC adapter (rated input power): 100-240 V $\sim$ 50-60 Hz 0.4 A AC adapter (rated output power): 5 V $\overline{\text{---}}$ 2.5 A
Dimension	65 (W) x 212 (D) x 71 (H) mm (Body portion)
Weight	Approx. 0.60kg (Body portion)
Selection between fluorescence and brightfield	Selection by IN to or OUT from microscope frame
Operating environment	<ul style="list-style-type: none"> <li>• Indoor use</li> <li>• Altitude: Max. 2000 meters</li> <li>• Ambient temperature: 5 to 40 °C (41 to 104 °F)</li> <li>• Humidity: Max. 80% (31 °C or less) (without condensation)                          In case of over 31 °C (88 °F), the humidity in operating environment is decreased linearly through 70% at 34 °C (93 °F), 60% at 37 °C (99 °F), and to 50% at 40 °C (104 °F).</li> <li>• Supply voltage fluctuation: <math>\pm 10</math> %</li> <li>• Pollution degree: 2 (in accordance with IEC60664-1)</li> <li>• Installation (overvoltage) category: II (in accordance with IEC60664-1)</li> </ul>

## ■ Proper selection of the power supply cord

If no power supply cord is provided, please select the proper power supply cord for the equipment by referring to “Specifications” and “Certified Cord” below:













**Caution : In case you use a non-approved power supply cord for our products, we can no longer warrant the electrical safety of the equipment.**







### Specifications

Voltage rating	125 V AC (for 100-120 V AC area) or, 250 V AC (for 220-240 V AC area)
Current rating	6 A minimum
Temperature rating	60 °C minimum
Length	3.05 m maximum
Fittings configuration	Grounding type attachment plug cap. Opposite terminates in molded-on IEC configuration appliance coupling.

**Table 1 Certified cord**

A power supply cord should be certified by one of the agencies listed in Table 1, or comprised of cordage marked with an agency marking per Table 1 or marked per Table 2. The fittings are to be marked with at least one of the agencies listed in Table 1. In case you are unable to buy locally the power supply cord which is approved by one of the agencies mentioned in Table 1, please use replacements approved by any other equivalent and authorized agencies in your country.

Country	Agency	Certification mark	Country	Agency	Certification mark
Argentina	IRAM		Italy	IMQ	
Australia	SAA		Japan	JET	
Austria	ÖVE		Netherlands	KEMA	
Belgium	CEBEC		Norway	NEMKO	
Canada	CSA		Spain	AEE	
Denmark	DEMKO		Sweden	SEMKO	

Country	Agency	Certification mark	Country	Agency	Certification mark
Finland	FEI		Switzerland	SEV	
France	UTE		United Kingdom	ASTA BSI	
Germany	VDE		U.S.A.	UL	
Ireland	NSAI				

**Table 2 HAR flexible cord**

Approval organizations and cordage harmonization marking methods

Approval organization	Printed or embossed harmonization marking (May be located on jacket or insulation of internal wiring)		Alternative marking utilizing black-red-yellow thread (Length of color section in mm)		
			Black	Red	Yellow
Comite Electrotechnique Belge (CEBEC)	CEBEC	⟨HAR⟩	10	30	10
Verband Deutscher Elektrotechniker (VDE) e.V. Prüfstelle	⟨VDE⟩	⟨HAR⟩	30	10	10
Union Technique de l'Electricite' (UTE)	USE	⟨HAR⟩	30	10	30
Instituto Italiano del Marchio di Qualita' (IMQ)	IEMMEQU	⟨HAR⟩	10	30	50
British Approvals Service for Electric Cables (BASEC)	BASEC	⟨HAR⟩	10	10	30
N.V. KEMA	KEMA-KEUR	⟨HAR⟩	10	30	30
SEMKO AB Svenska Elektriska Materielkontrollanstalter	SEMKO	⟨HAR⟩	10	10	50
Österreichischer Verband für Elektrotechnik (ÖVE)	⟨ÖVE⟩	⟨HAR⟩	30	10	50

Approval organization	Printed or embossed harmonization marking (May be located on jacket or insulation of internal wiring)		Alternative marking utilizing black-red-yellow thread (Length of color section in mm)		
			Black	Red	Yellow
Danmarks Elektriske Materialkontroll (DEMKO)	⟨DEMKO⟩	⟨HAR⟩	30	10	30
National Standards Authority of Ireland (NSAI)	⟨NSAI⟩	⟨HAR⟩	30	30	50
Norges Elektriske Materiellkontroll (NEMKO)	NEMKO	⟨HAR⟩	10	10	70
Asociacion Electrotecnica Y Electronica Espanola (AEE)	⟨UNED⟩	⟨HAR⟩	30	10	70
Hellenic Organization for Standardization (ELOT)	ELOT	⟨HAR⟩	30	30	70
Instituto Portages da Qualidade (IPQ)	np	⟨HAR⟩	10	10	90
Schweizerischer Elektro Technischer Verein (SEV)	SEV	⟨HAR⟩	10	30	90
Elektriska Inspektoratet	SETI	⟨HAR⟩	10	30	90

Underwriters Laboratories Inc. (UL)  
Canadian Standards Association (CSA)

SV, SVT, SJ or SJT, 3 X 18AWG  
SV, SVT, SJ or SJT, 3 X 18AWG



This product is manufactured by **EVIDENT CORPORATION** effective as of Apr. 1, 2022.  
Please contact our "Service Center" through the following website for any inquiries or issues related to this product.

# EVIDENT CORPORATION

6666 Inatomi, Tatsuno-machi, Kamiina-gun, Nagano 399-0495, Japan

(Life science solutions)

## Service Center

<https://www.olympus-lifescience.com/support/service/>



(Life science solutions)

## Our Website

<https://www.olympus-lifescience.com>



(Industrial solutions)

## Service Center

<https://www.olympus-ims.com/service-and-support/service-centers/>



(Industrial solutions)

## Our Website

<https://www.olympus-ims.com>



AX9457 03

Issued in April, 2022